

GREEN MOSQUES INITIATIVE

Empowering Community-Led
Sustainable Solutions

AUTHORS



The Lebanese
Foundation for
Renewable Energy



Issam Fares Institute for Public
Policy and International Affairs
مركز دراسات السياسات
والعامة والشؤون الدولية



National Council for Scientific Research

GREENPEACE
غرينبيس



Ummah for Earth
Protect to progress



Table of Contents

Preface	3
Executive Summary	4
Introduction and Methodology	13
Al Nabawi Mosque	17
Glasgow Central Mosque	28
Al Azhar Mosque	38
Grand Jamia Mosque	48
Istiqlal Mosque	58
Great Mosque of Algiers	68
Nizamiyeh Mosque	78
Al Haram Mosque	88
Ummayed Mosque	98
Hassan II Mosque	108
Conclusion	118

Preface

As an alliance-led initiative, Ummah for Earth is working to empower Muslim communities - especially those at the front lines of the climate crisis, to take more initiative and lead the way towards a green and just transition to a sustainable world.

As we endeavour to amplify Muslim voices within the broader climate movement, we also seek opportunities to demonstrate the value of promoting and enabling community-led solutions. Solutions and initiatives that can serve as an example to others around the world, and catalyse the changes we are all working to manifest.

This report shows the potential that the Ummah has to be part of the solution not only through the direct environmental benefits of 'greening' these Mosques but also because of their potential to influence people as centres of culture, spirituality and community life. They are an expression of the willingness of Muslims and religious leaders to be part of the climate solution!

The report represents the first step of a journey of a thousand miles. It began with a big idea and some questions: what if all mosques in the world were equipped with solar energy systems? How could that be achieved? What impact would it have on the communities these centres of worship serve? How will it help mitigate the effects of climate change?

With these questions in mind, we took the first step by selecting ten mosques from around the world that can serve as examples, and commissioned a detailed technical analysis of the feasibility and impact of installing solar energy systems at the sites. The report was developed by a team from the Issam Fares Institute for Public Policy and International Affairs at the American University of Beirut, in collaboration with The Lebanese Foundation for Renewable Energy and the National Council for Scientific Research.

Just days before the publication and release of this report, we are excited to see the Glasgow Central Mosque in Scotland leading the way by installing a solar system after receiving a generous grant from Islamic Relief, a member of the Ummah for Earth alliance.

Our hope is for this report to be an inspiration, and for this initiative to instigate a domino effect of green mosques. Grand ideas can be turned into physical realities, especially when we can muster our collective passion, solidarity and conviction to achieve them.

Ghiwa Nakat

Executive Director, Greenpeace Middle East and North Africa



Executive Summary

This report studies the **potential** social, environmental and financial impact of installing PV systems at 10 major mosques around the world.

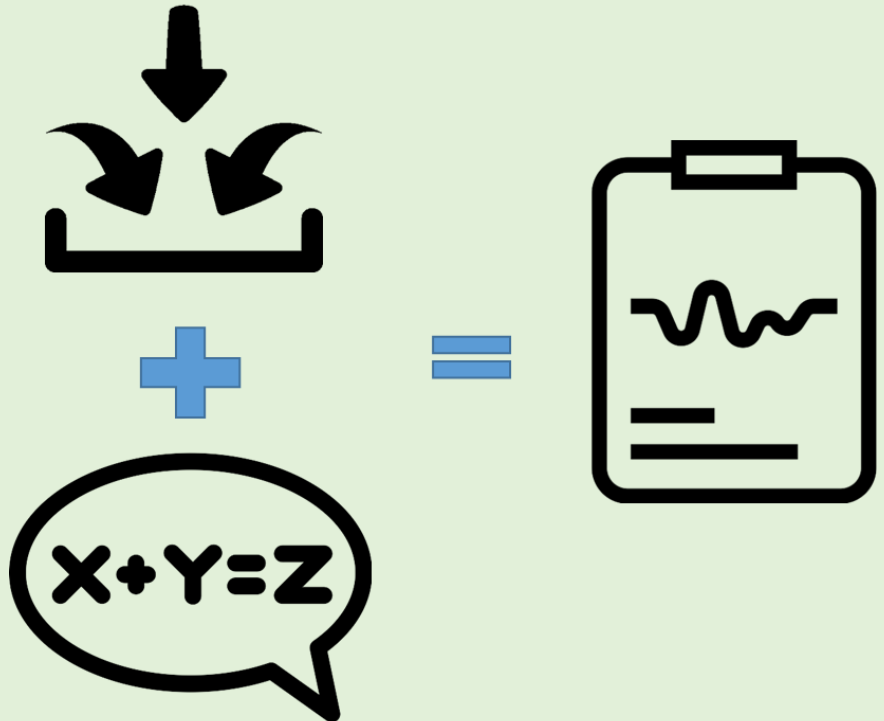



The adjacent map shows the 10 mosques which have been studied.

PV POWER AND ENERGY

■ Power (kW) ■ AEP (MWh/yr)

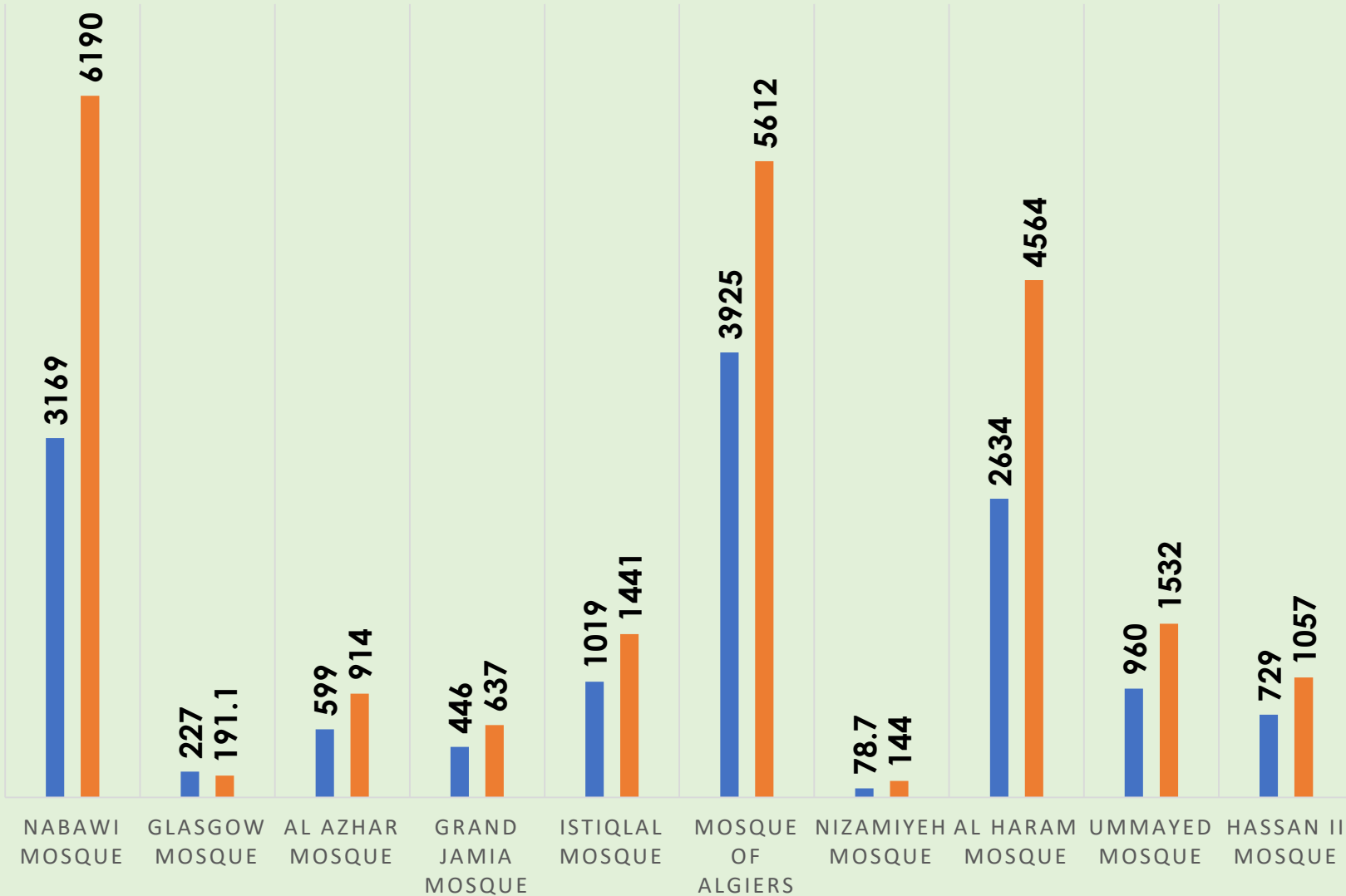

Technical Findings

Comparing power output and annual electricity production

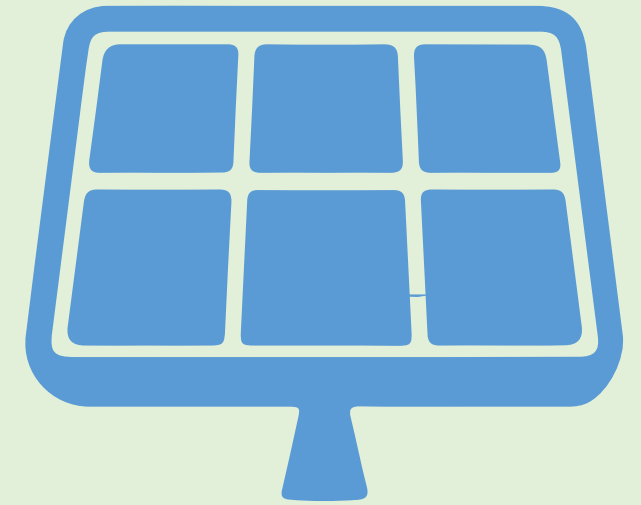

FINANCIAL VIABILITY

■ IRR (%) ■ Payback ■ B-C Ratio

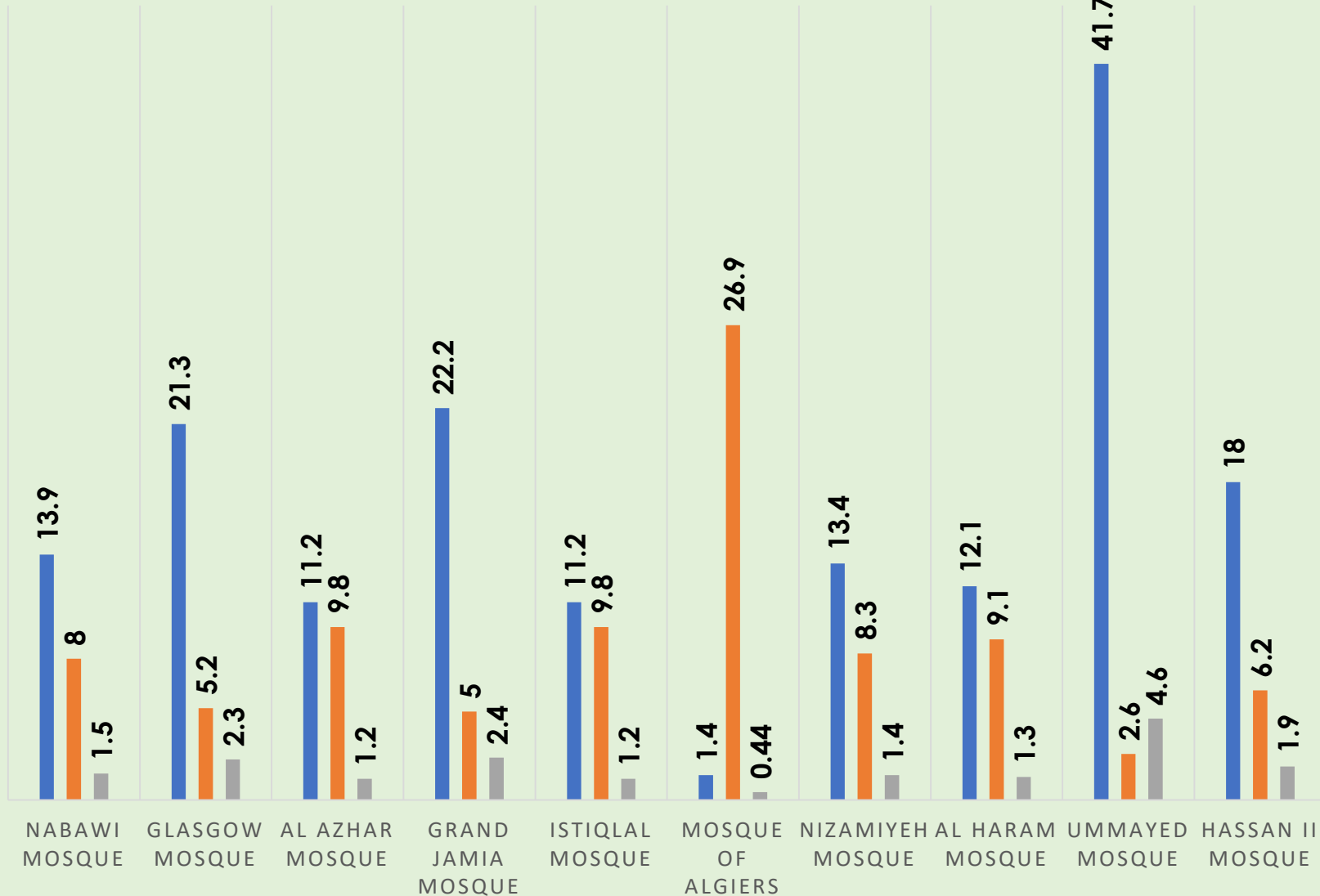

Economic Findings

Internal rate of return Vs Payback and Benefits:Costs ratio



ANNUAL SAVINGS

(\$/yr)

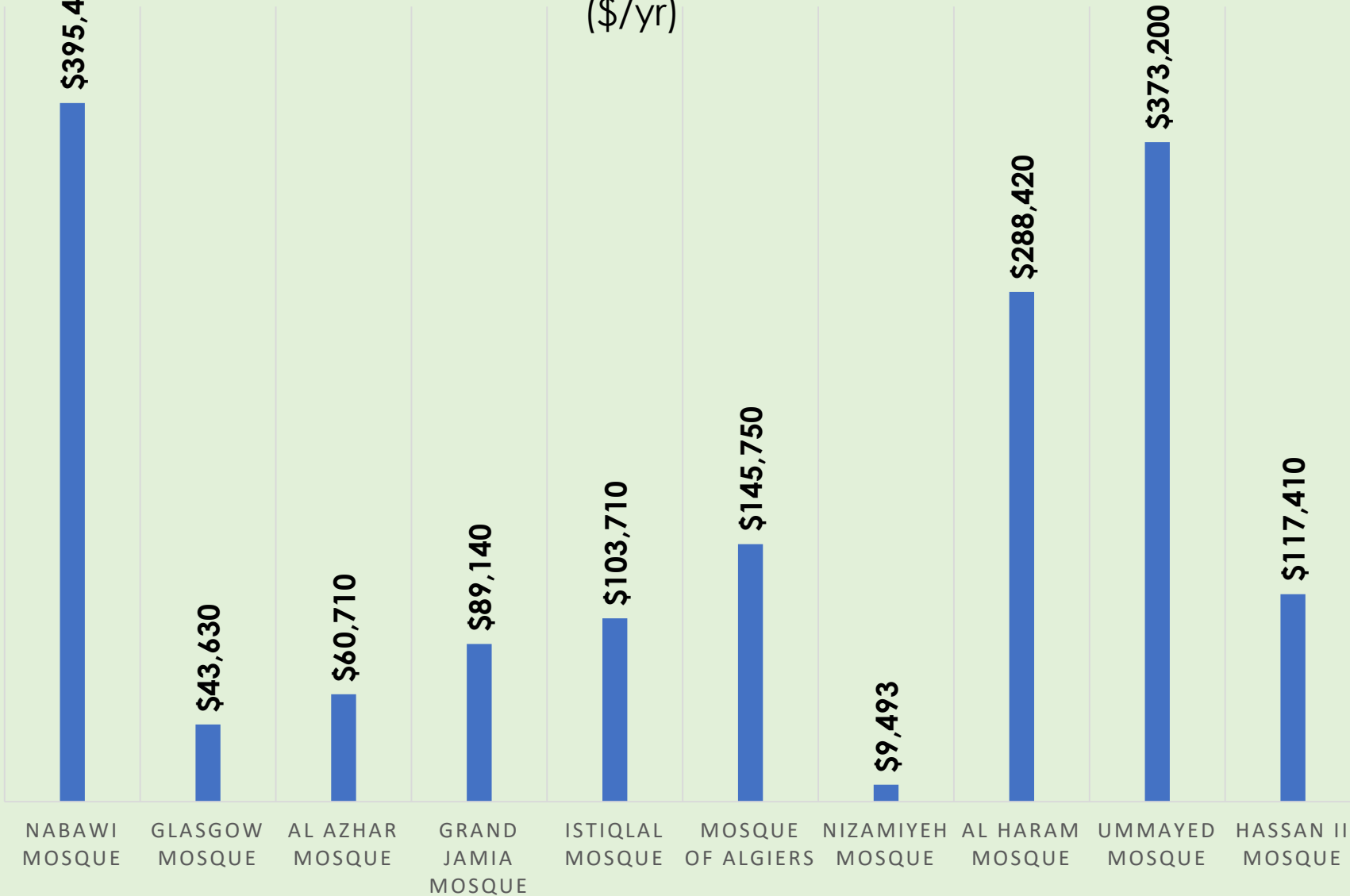

Economic Findings



AVERAGE EMPLOYMENT OVER LIFE OF FACILITY

■ Minimum Job ■ Maximum Job

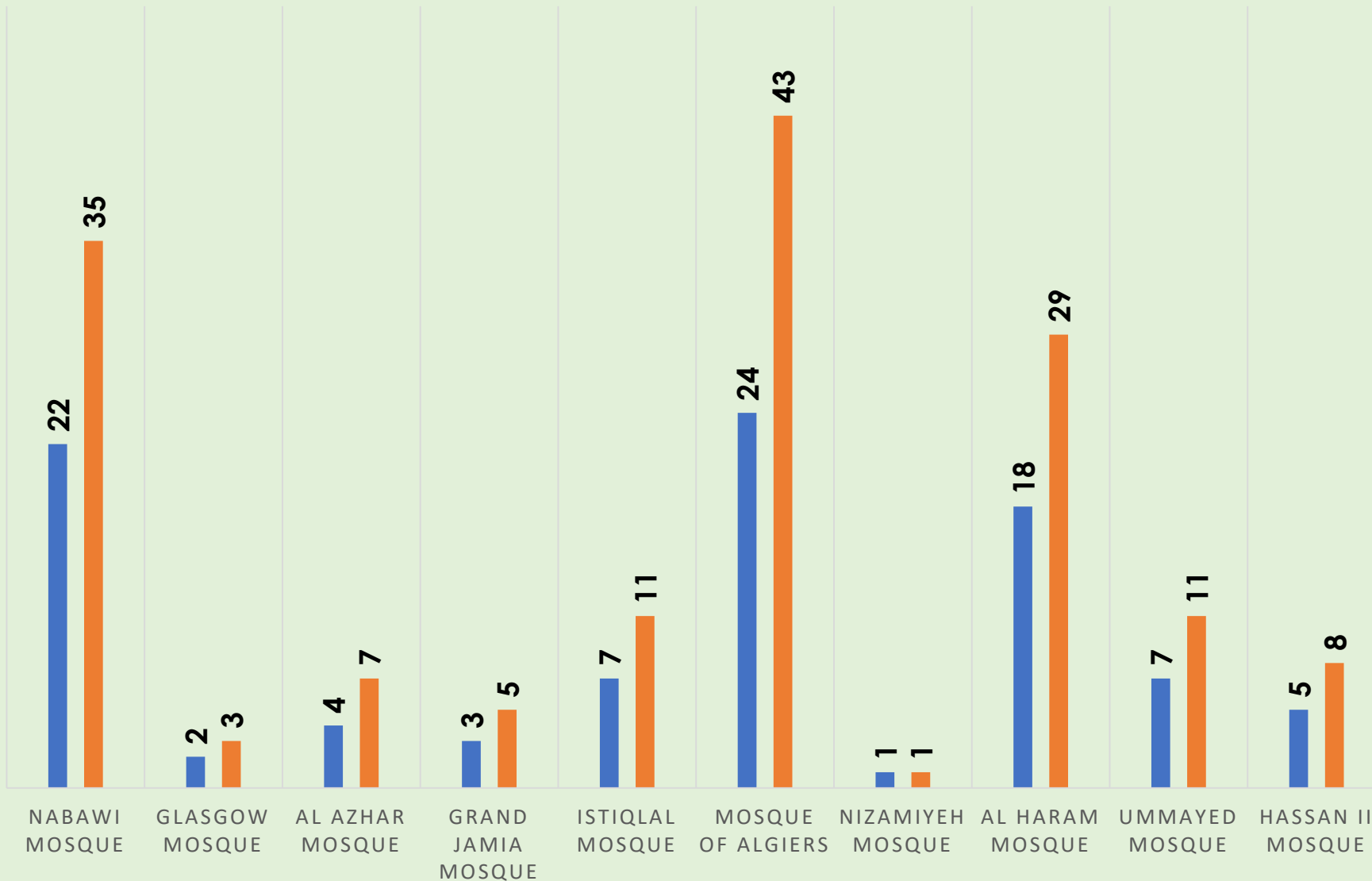

Social Findings



Total number of jobs created ranges between
93 & 153

REDUCTIONS IN ANNUAL GREENHOUSE GAS EMISSIONS (TCO2/Y)

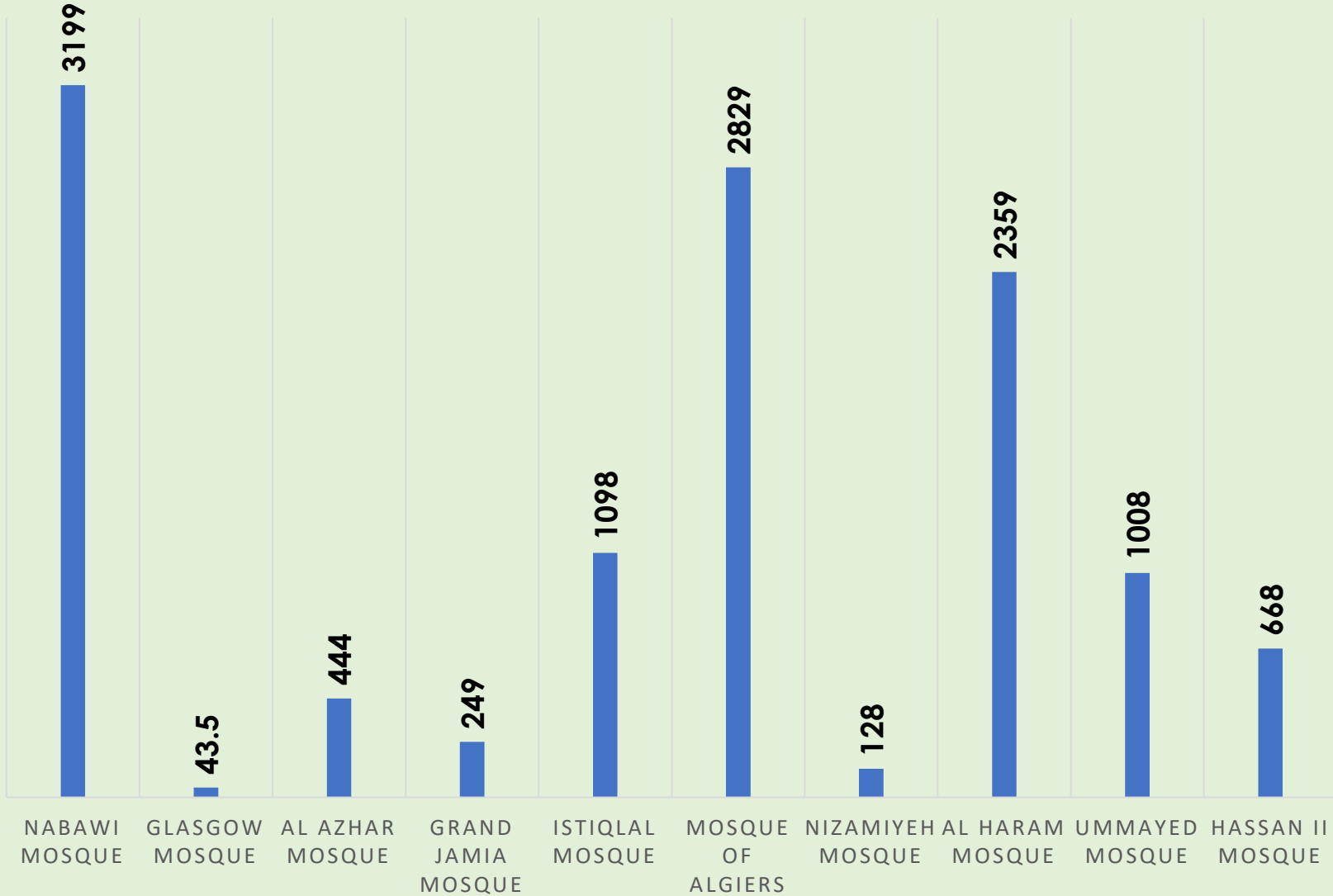

Environmental Findings

CO₂

A total annual reduction of 12025 tonnes of CO₂

Equivalent to

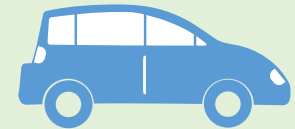

2203 cars and light trucks not used per year



5,166,844 Liters of gasoline not consumed

=



1107 Hectares of forest absorbing carbon

COVERAGE OF MOSQUES' ENERGY DEMAND

%

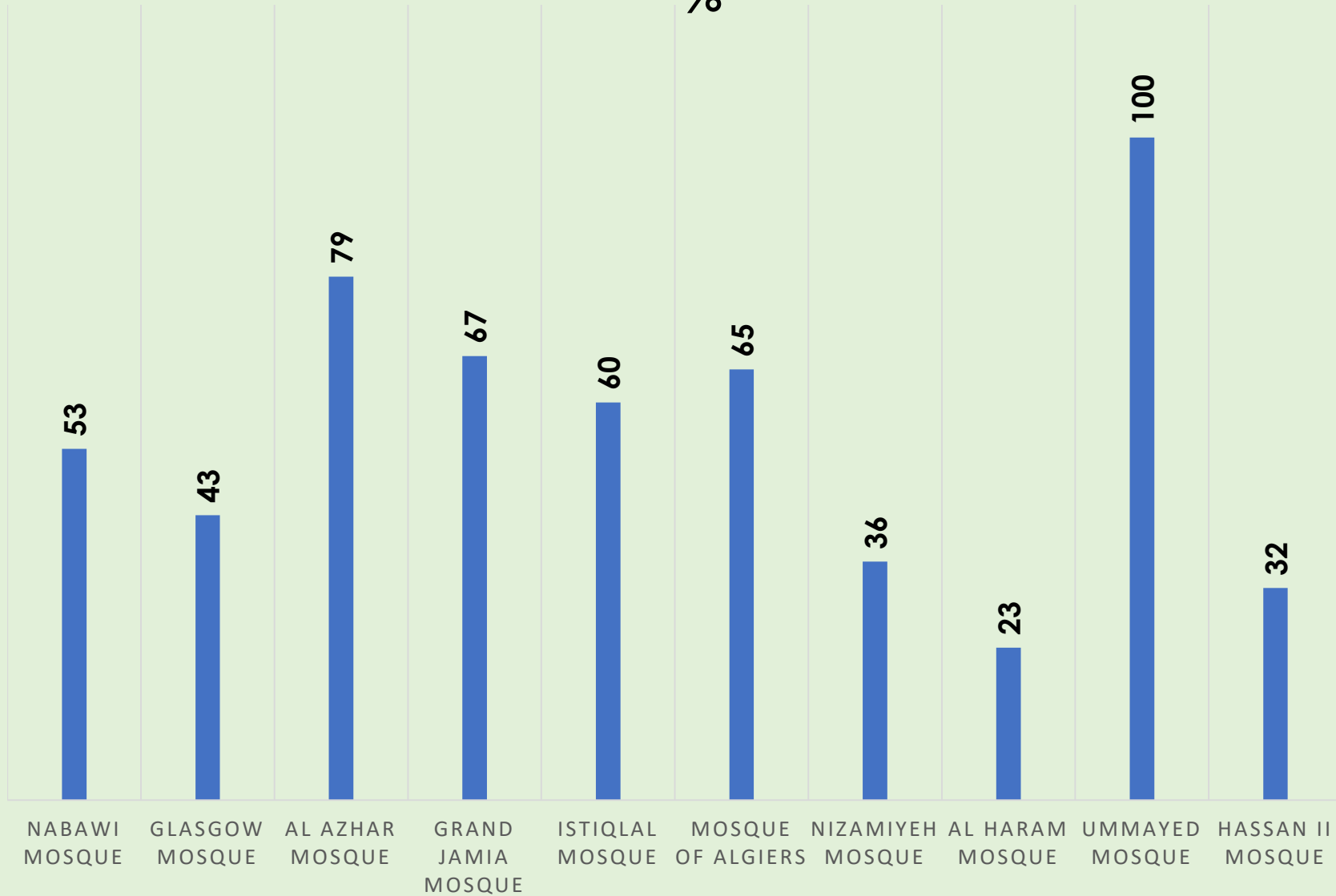

Equivalent to



6548 Households
reducing energy
by 100%

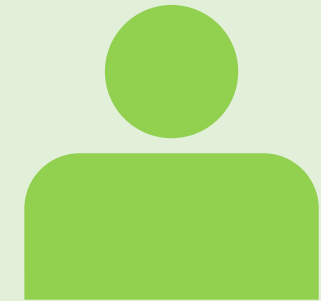

37980 persons
reducing energy
by 100%



Introduction and Methodology

Converting these mosques to full or partial solar power can have a real and measurable impact on greenhouse gas emissions, as well as viable financial and social benefits.

These mosques can serve as examples for the communities around them and others all over the world, to inspire the adoption of sustainable solutions and transition away from the need for energy production based on fossil fuels.



Software Used

In order to conduct a reliable and accurate study for calculating the potential of a PV system on the Mosque's rooftops, and determine the economic and social benefits, a group of software were used. Each one has its own mission (see the adjacent text)



ArcMap



RETScreen
Expert



1. **ArcMap**: for mapping and modelling

2. **Sketchup**: 3D modelling

3. **PVsyst**: PV design for small areas

4. **RETScreen**: for economic and environmental studies

01

Solar Energy Assessment

Determination of the available solar energy which depends on the location

02

Solar Site Assessment

Determination of the suitable and available area for installing PV system through mapping and modelling

03

Design of PV System

Simulation and detailed design of PV system using energy software.

04

Economic & Environment studies

Determination of CO₂ emissions and economic feasibility study

1-Al Nabawi Mosque

Preliminary Solar Energy Assessment



This mosque is located in Madina, Saudi Arabia. ($24^{\circ}28'13.1''\text{N}$ $39^{\circ}36'36.9''\text{E}$)

The optimal tilt angle of PV module is 25° and azimuth is south facing.

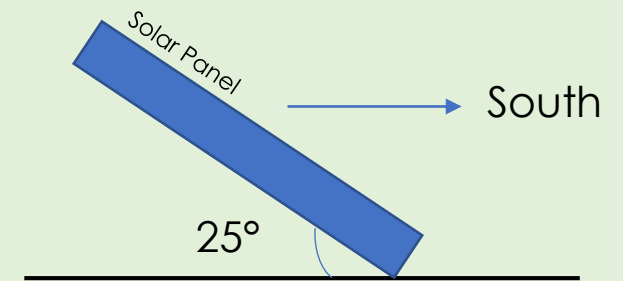

Source: Global Solar Atlas

Preliminary Solar Energy Assessment

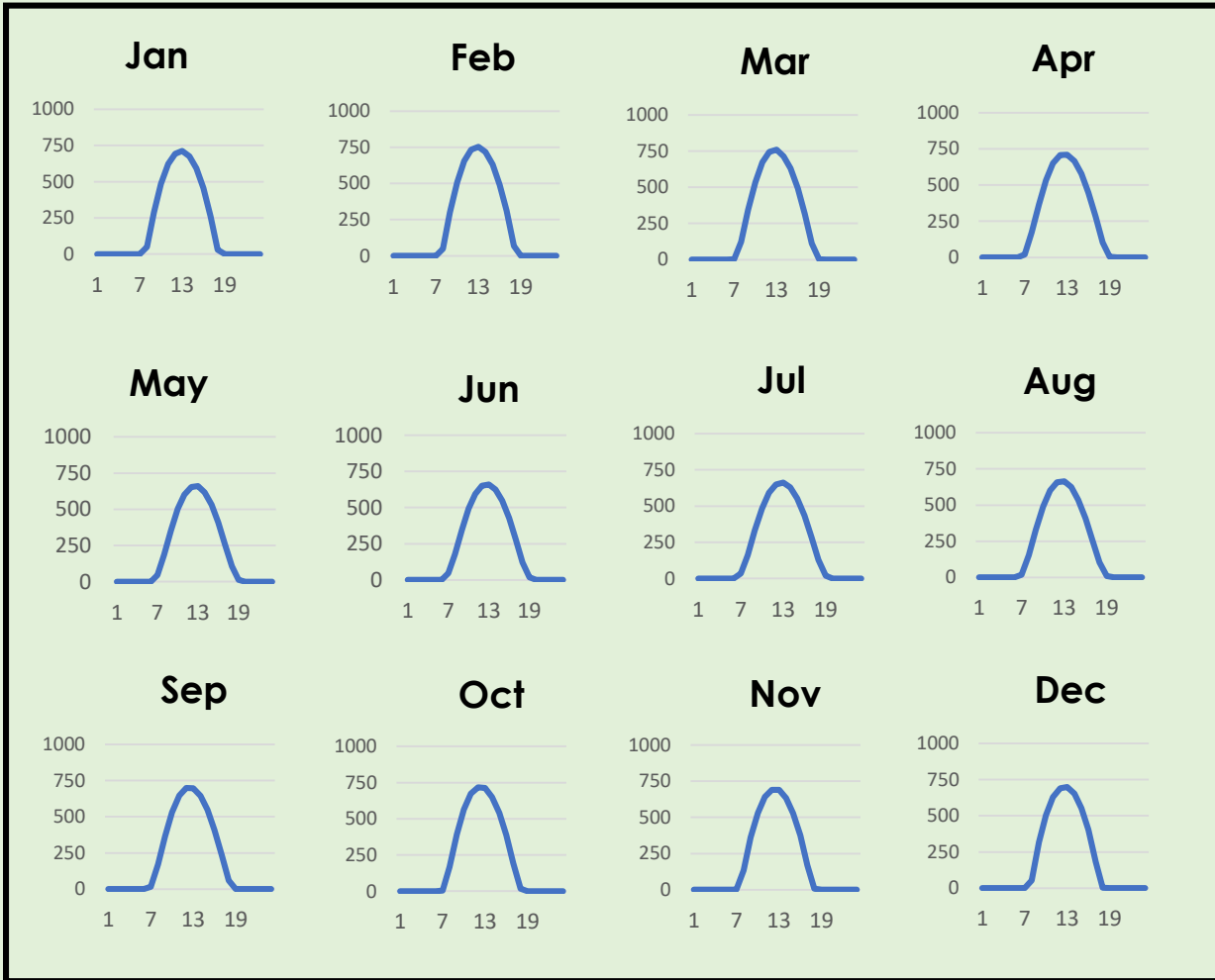

Average hourly profiles for each month
Total photovoltaic power output [Wh]

Total Photovoltaic Power Output per year
= 1824 kWh/kWp

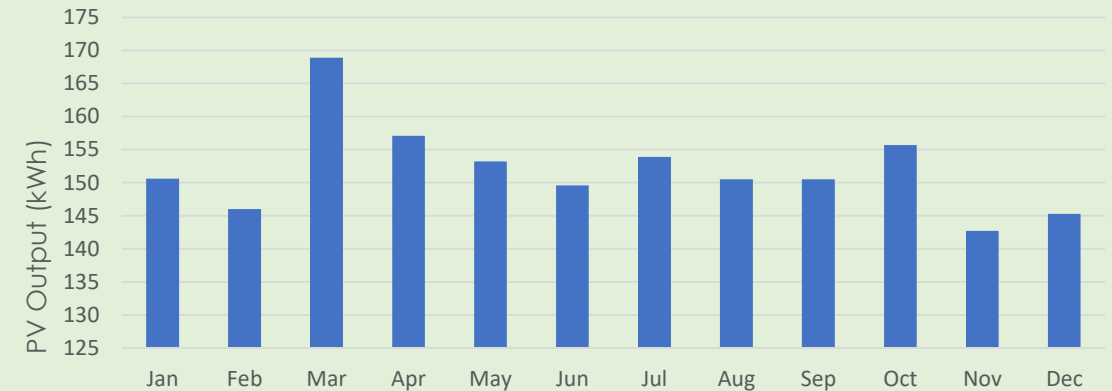

Monthly Averages

Total photovoltaic power output [kWh]

The figures show the hourly and monthly operation of 1 kWp PV system installed at Al Madina town. We can conclude that the energy production is approximately constant throughout the year, with high potential of solar energy.

Data source : Global Solar Atlas

Preliminary Solar Site Assessment

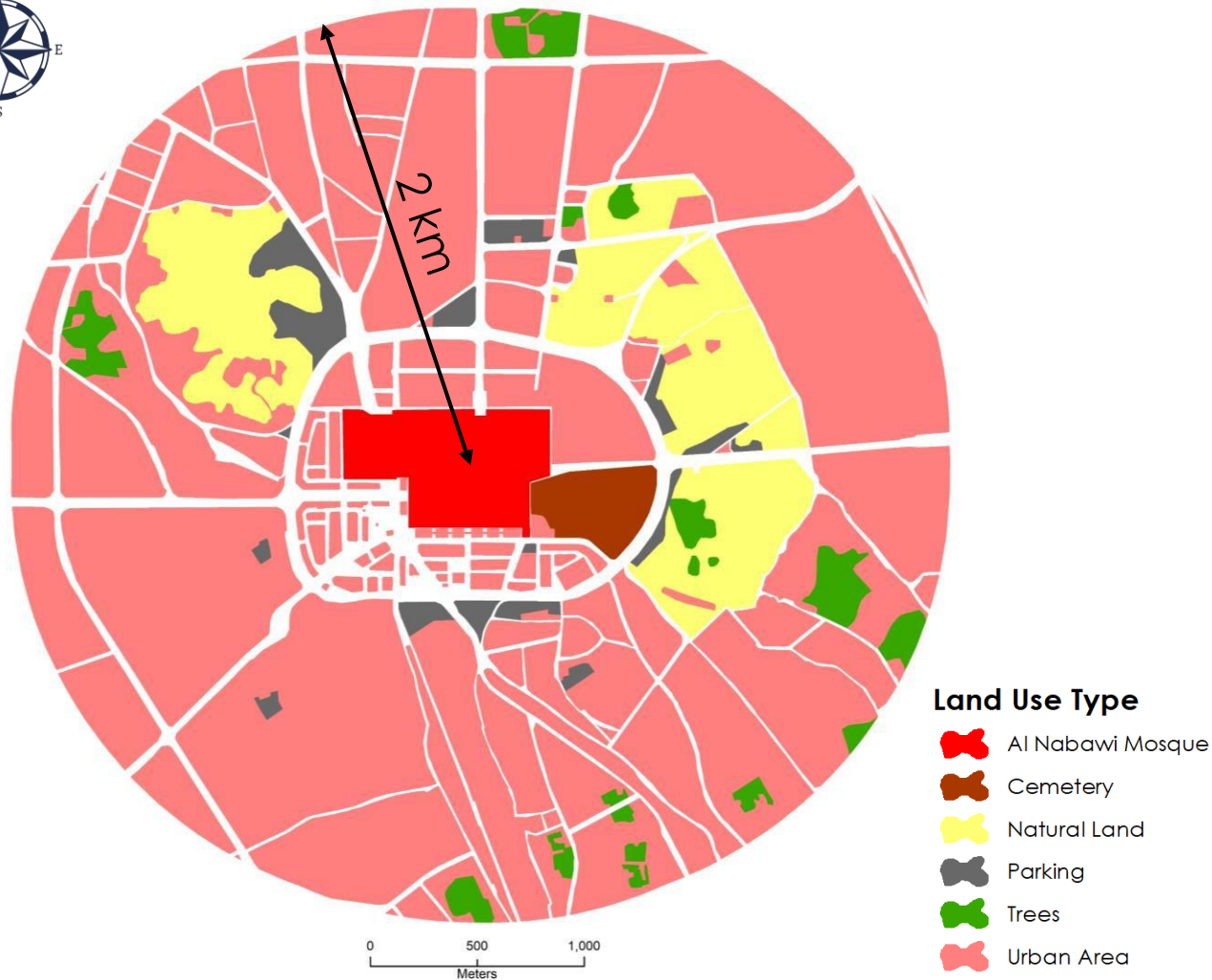

The adjacent map shows the land use type at radius 2 km from the mosque. Al Nabawi mosque is located in a high density urban area with a few green areas.

To the west of the mosque, a mountain is located (yellow) which can be a suitable location for installing PV system. (The slope and aspect of mountain must be checked.)

To the east of the mosque, there is a cemetery with area 177,000 m² which can be used for installing PV system at a height of 5m from the ground. In addition to some open plots (yellow) with a total area of 1,088,000 m² which also can suitable locations for installing PV systems.

Preliminary Solar Site Assessment

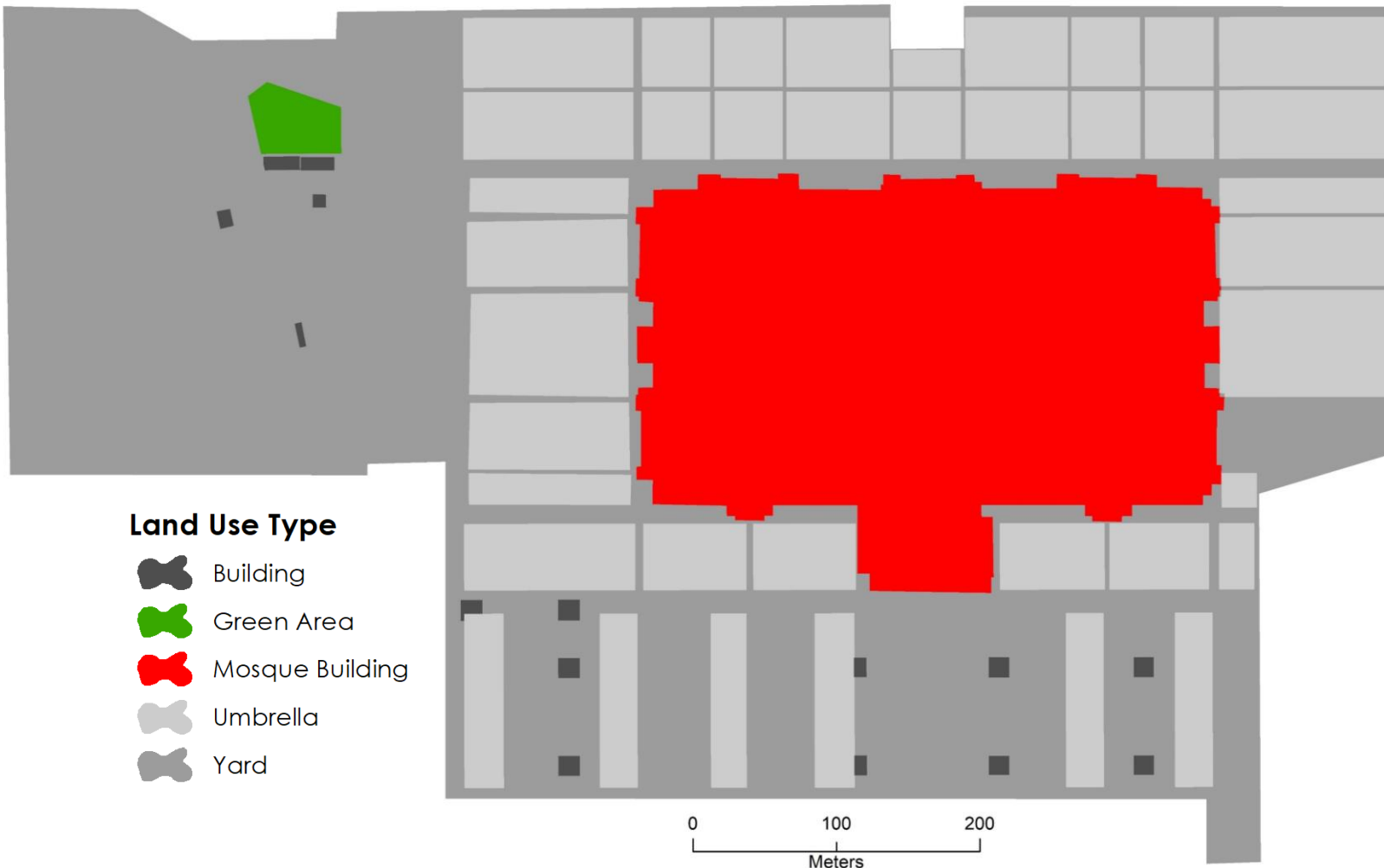

- Total area of the plot where the mosque is located is around 440,000 m², of which mosque's building around 95,000 m².
- The mosque includes automatic umbrellas that open in morning and close in evening. Their total area around 140,000 m².
- PV system can be installed at the rooftop of the mosque and at the yard to the west of the mosque.

Preliminary Solar Site Assessment

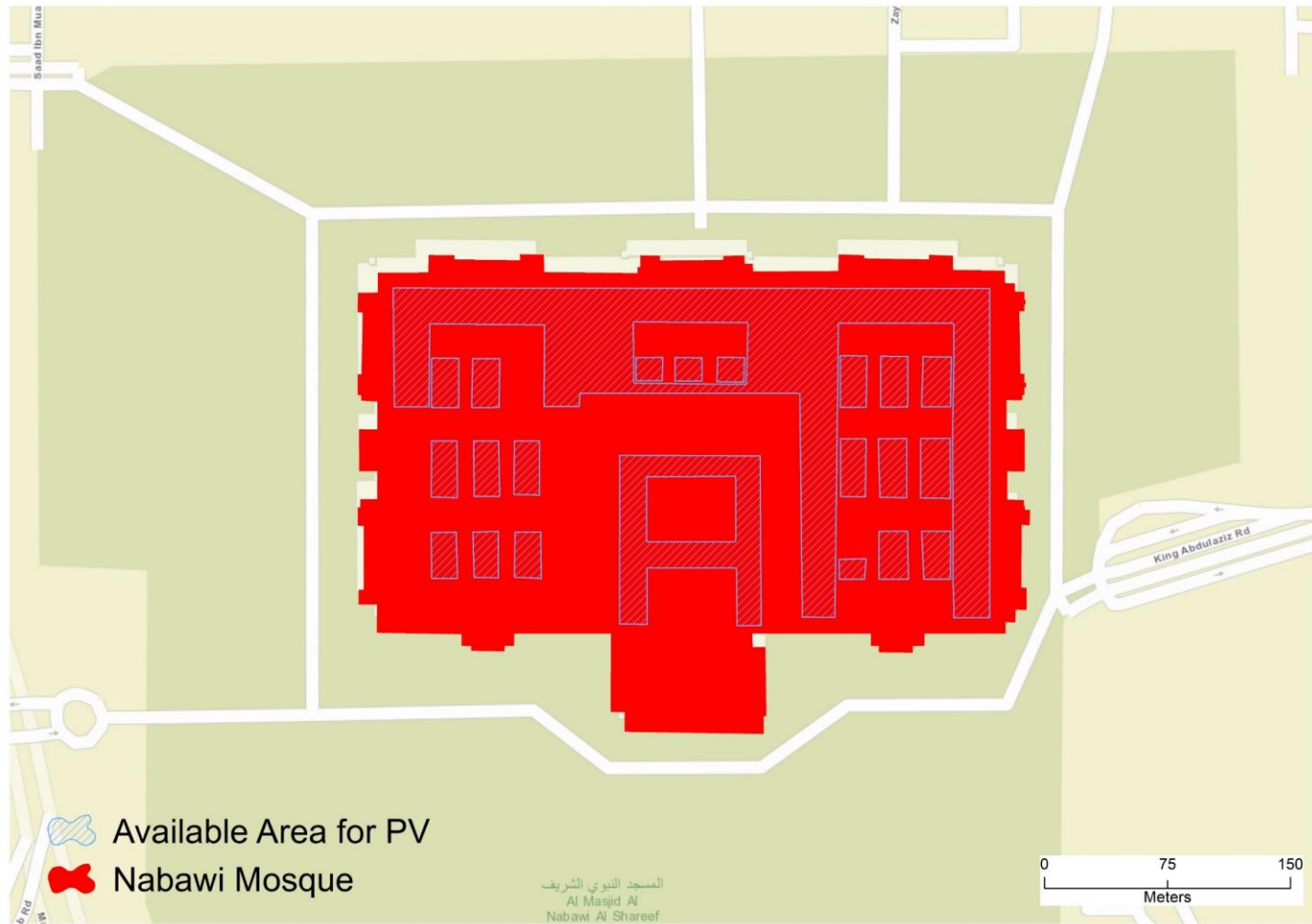

- The rooftop area of the mosque is: **95,900** m²
- Total area available for installing a PV system is : **35,020** m²

PV Design of Mosque's Rooftop

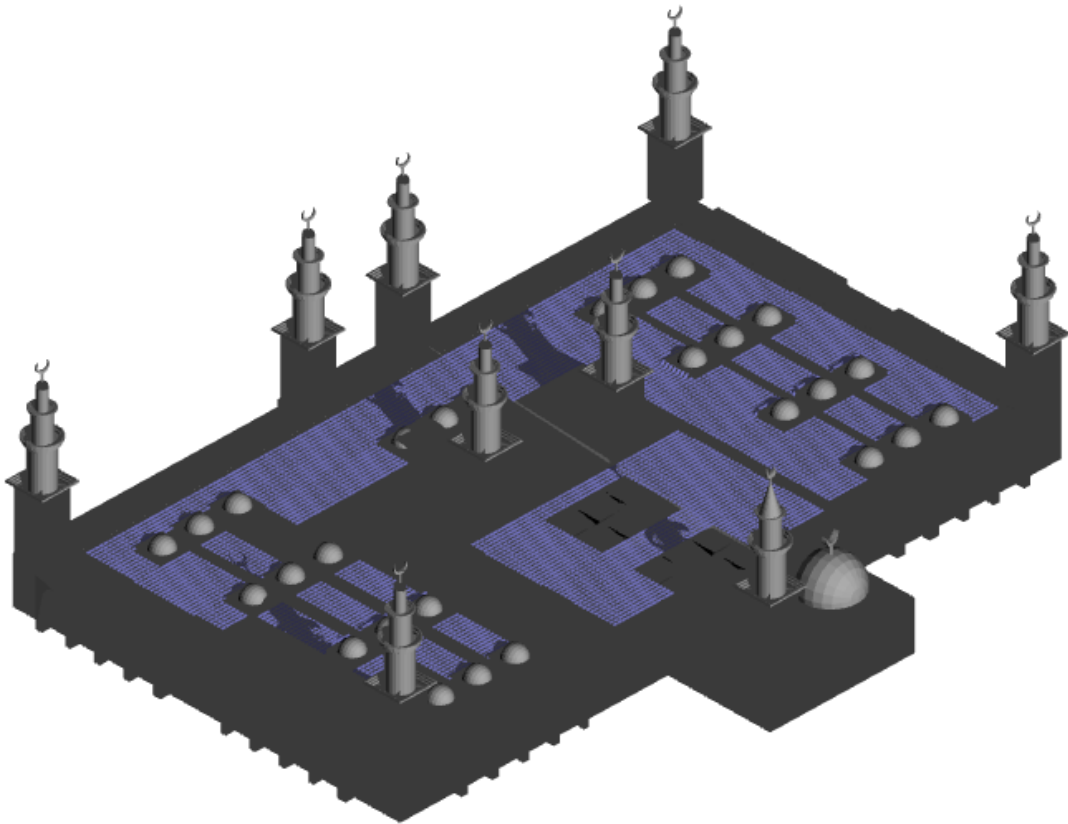

	Solar System Parameters
PV Module	Model: LR5-72 HPH 540 M
Manufacturer	Longi Solar
Nominal PV Power (kWp)	3169
Total Number of modules	5868 (18 in series , 326 in Parallel)
Total Area of Modules (m ²)	15,000
Total Number of Sheds	6035
Inverter	Model: CORE-1000.0-TL
Manufacturer	ABB
Nominal Inverter Power (kWac)	3000 (3 inverters each 1000 kW)
System Production	
Total Produced Energy (MWh/year)	6190
System Performance Ratio (%)	76
System Cost	\$3,169,000

Economic Benefits

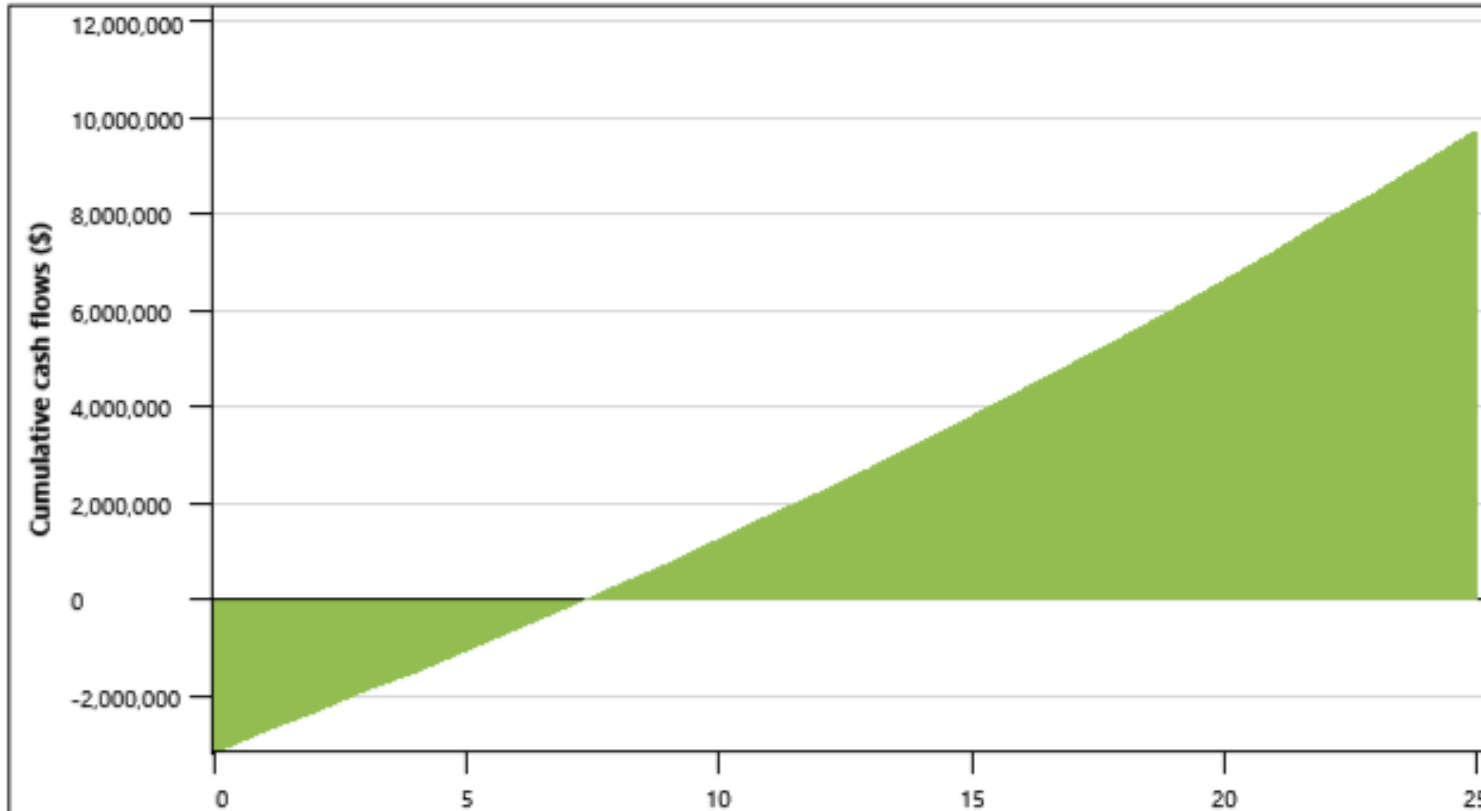

- Total Initial Cost = **\$3,169,000**
(Considering 1000 \$ /KWp - Ref: RETScreen)
- O&M Cost = **\$31,690/yr**
(Considering 10 \$ /KWp/yr - Ref: RETScreen)
- Savings = **\$395,420/yr**
(0.069\$/kWh in Saudi Arabia – Ref: Global Petrol Prices)
- NPV = **\$1,497,073**
- IRR = **13.9%**
- Simple payback = **8 yr**
- Benefit-Cost Ratio = **1.5**

Potential Jobs Created

Source: UNEP/ILO/IOE/ITUC, 2008.



22 - 35

Average employment (jobs per megawatt of solar photovoltaic system) over life of facility including manufacturing, construction, installation and operation & maintenance [ranges between 6.96 and 11.01 per MW](#)

Environmental Benefits

According to **RETScreen software**, the GHG emission for **1 kWh** is **0.556 kgCO₂/kWh**. Referring to the energy produced by PV system which is around **6.19 GWh**, the gross annual GHG emission reduction CO₂ is **3199 TCO₂/yr** would be equivalent to:



586 cars and light trucks not used per year

1,374,646 Liters of gasoline not consumed

1435 citizens reducing energy by 100%

1103 Tonnes of waste recycled

294 Hectares of forest absorbing carbon

Additional Benefits

Source: RETScreen

Coverage of Energy Demand

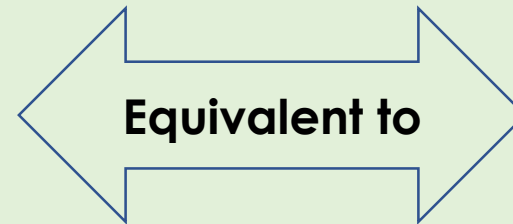
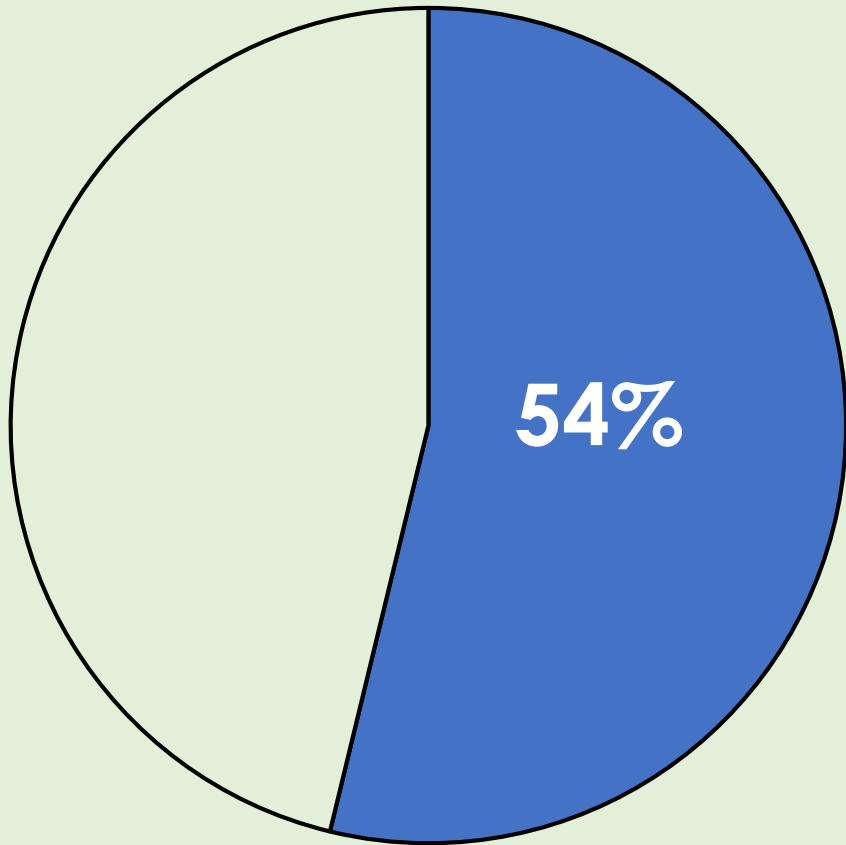

1435 Citizens

The yearly average consumption of a religious building is **120** kWh/m²



2- Glasgow Central Mosque

Preliminary Solar Energy Assessment

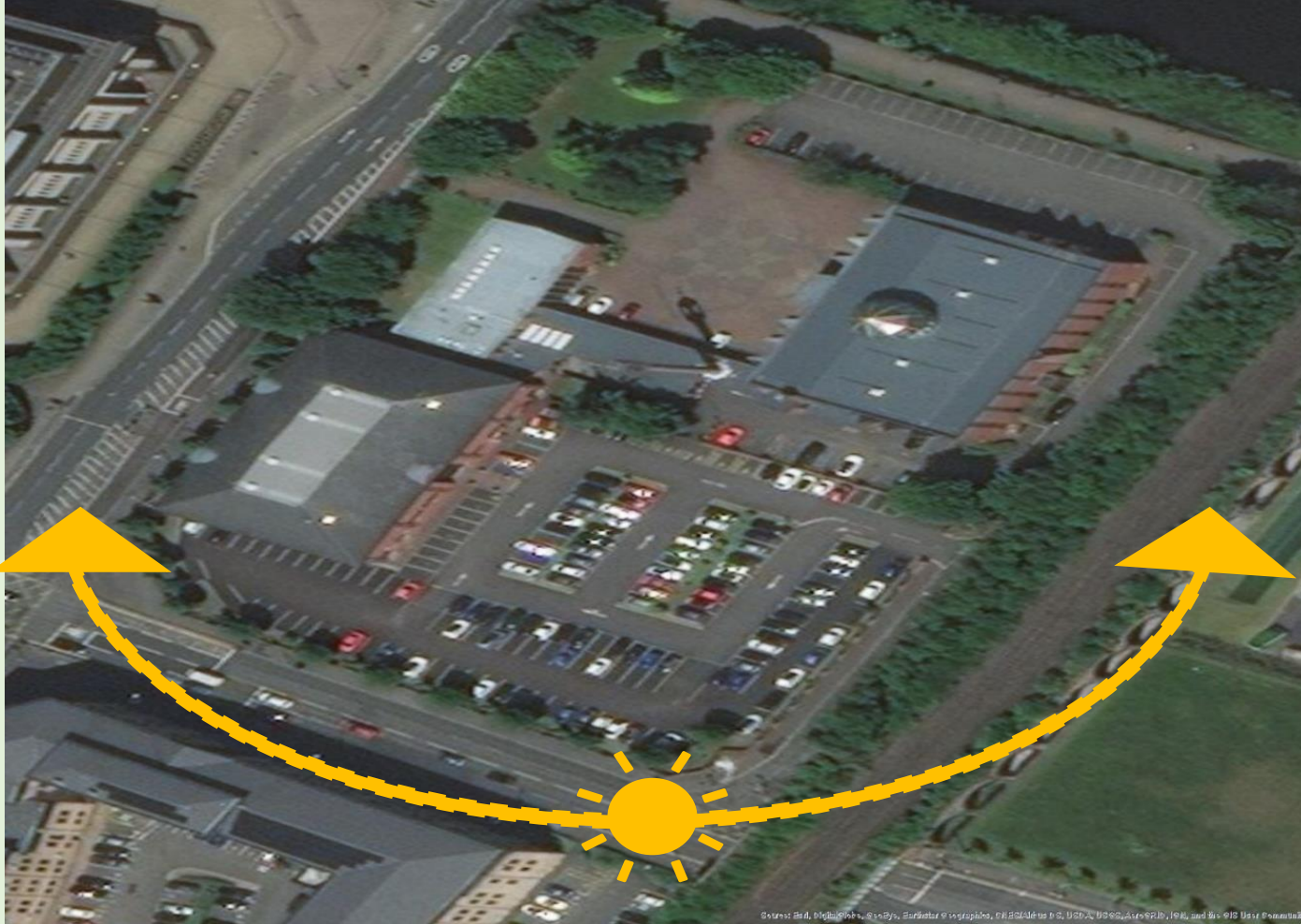

This mosque is located in Glasgow, Scotland. ($55^{\circ}51'07.6''\text{N}$ $4^{\circ}15'07.4''\text{W}$)

The optimal tilt angle of PV module is 38° and azimuth is south facing.

This mosque has already been partially equipped with solar energy.

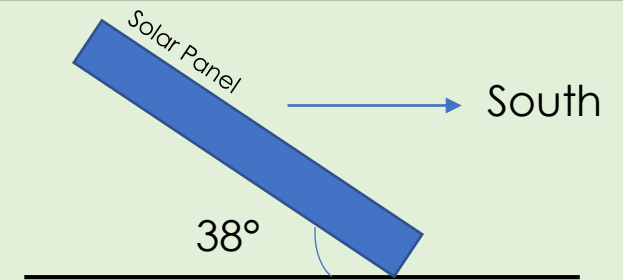

Source: Global Solar Atlas

Preliminary Solar Energy Assessment

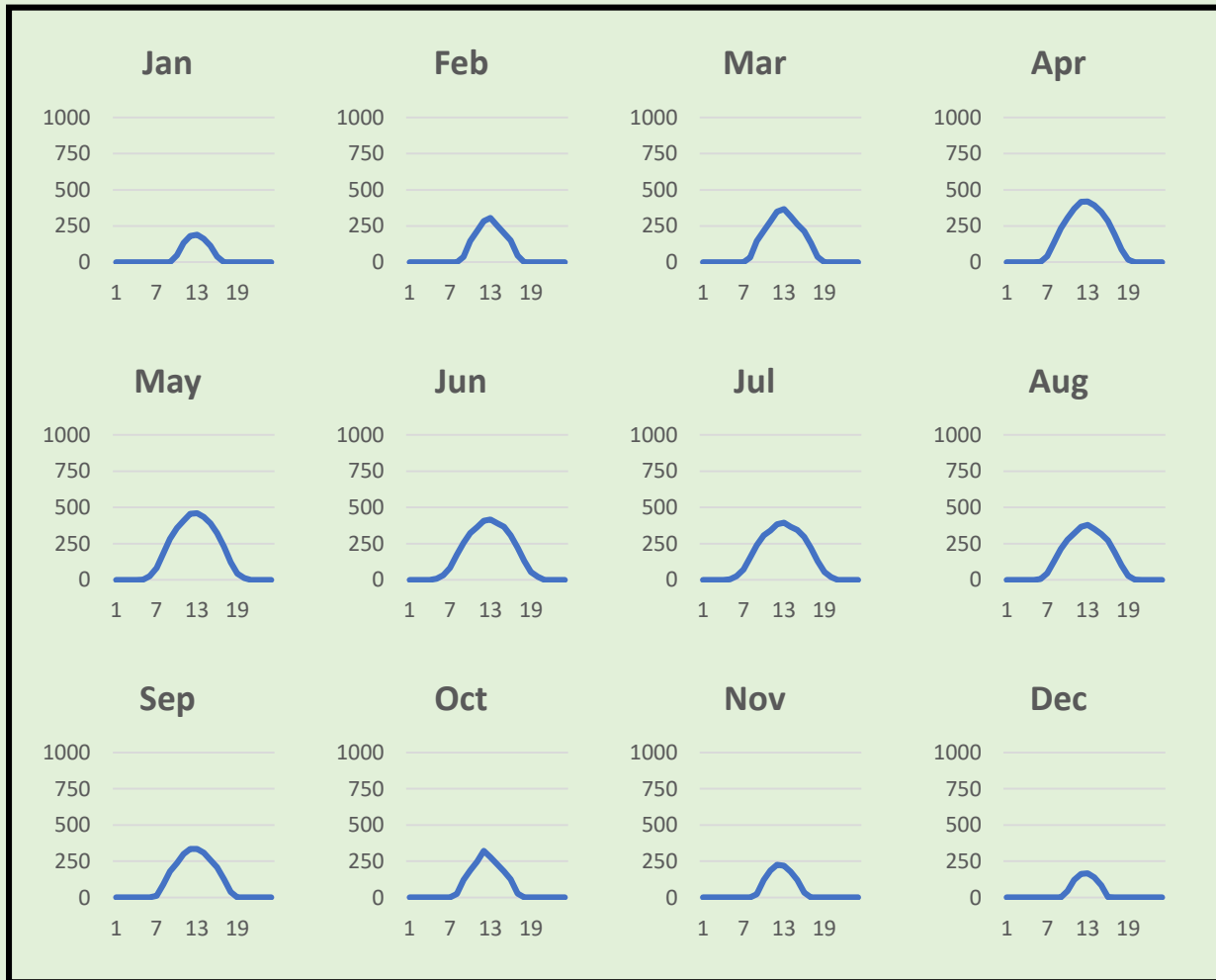

Average hourly profiles for each month
Total photovoltaic power output [Wh]

Total Photovoltaic Power Output per year
= **845 kWh/kWp**

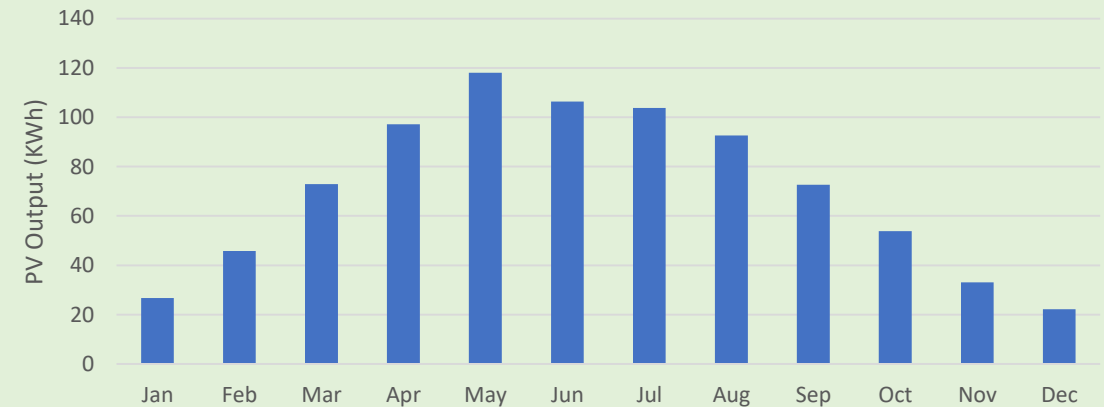

Monthly Averages

Total photovoltaic power output [kWh]

The figures show the hourly and monthly operation of 1 kWp PV system installed at Glasgow. We can conclude that the energy production ranges between 22 kWh/yr and 118 kWh/yr, with Low potential of solar energy.

Data source : Global Solar Atlas

Preliminary Solar Site Assessment

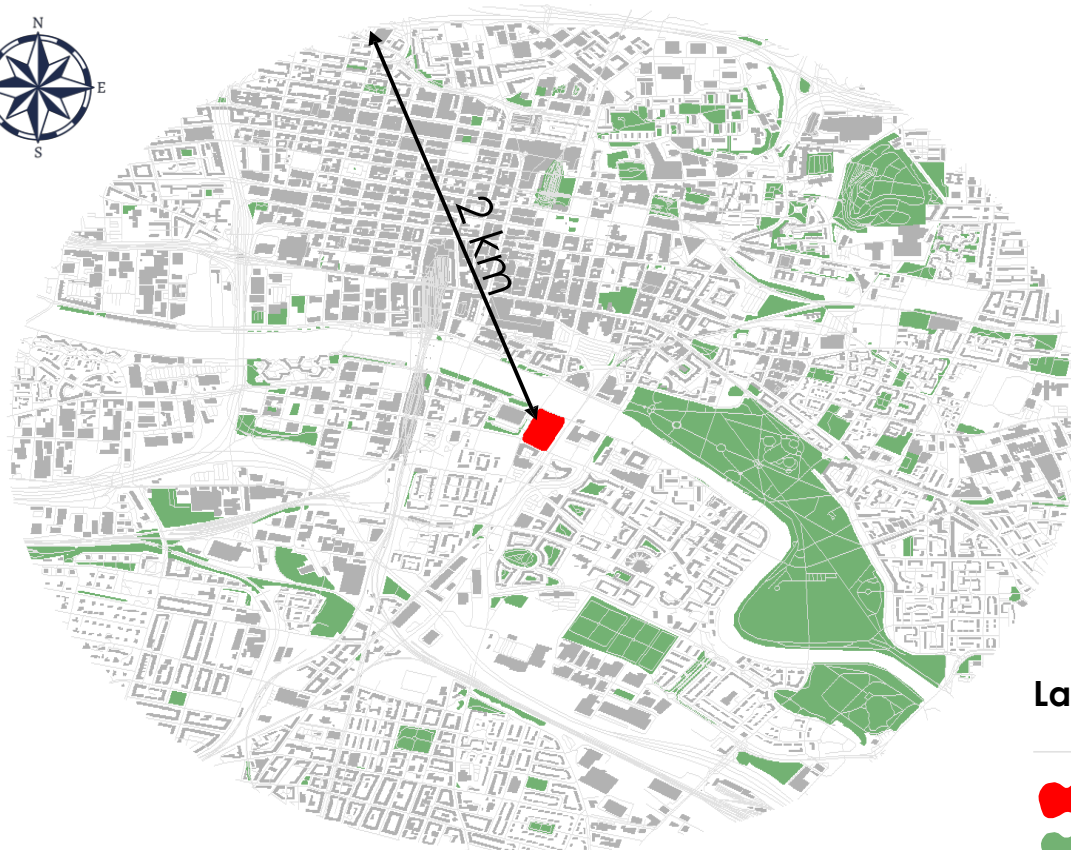

0 500 1,000
Meters

Land Use Type

- Roads
-  Glasgow Mosque
-  Green Area
-  Urban Area

The adjacent map shows the land use type at radius 2 km from the mosque. Glasgow mosque is located in a high density urban area with medium distribution of green areas.

Preliminary Solar Site Assessment

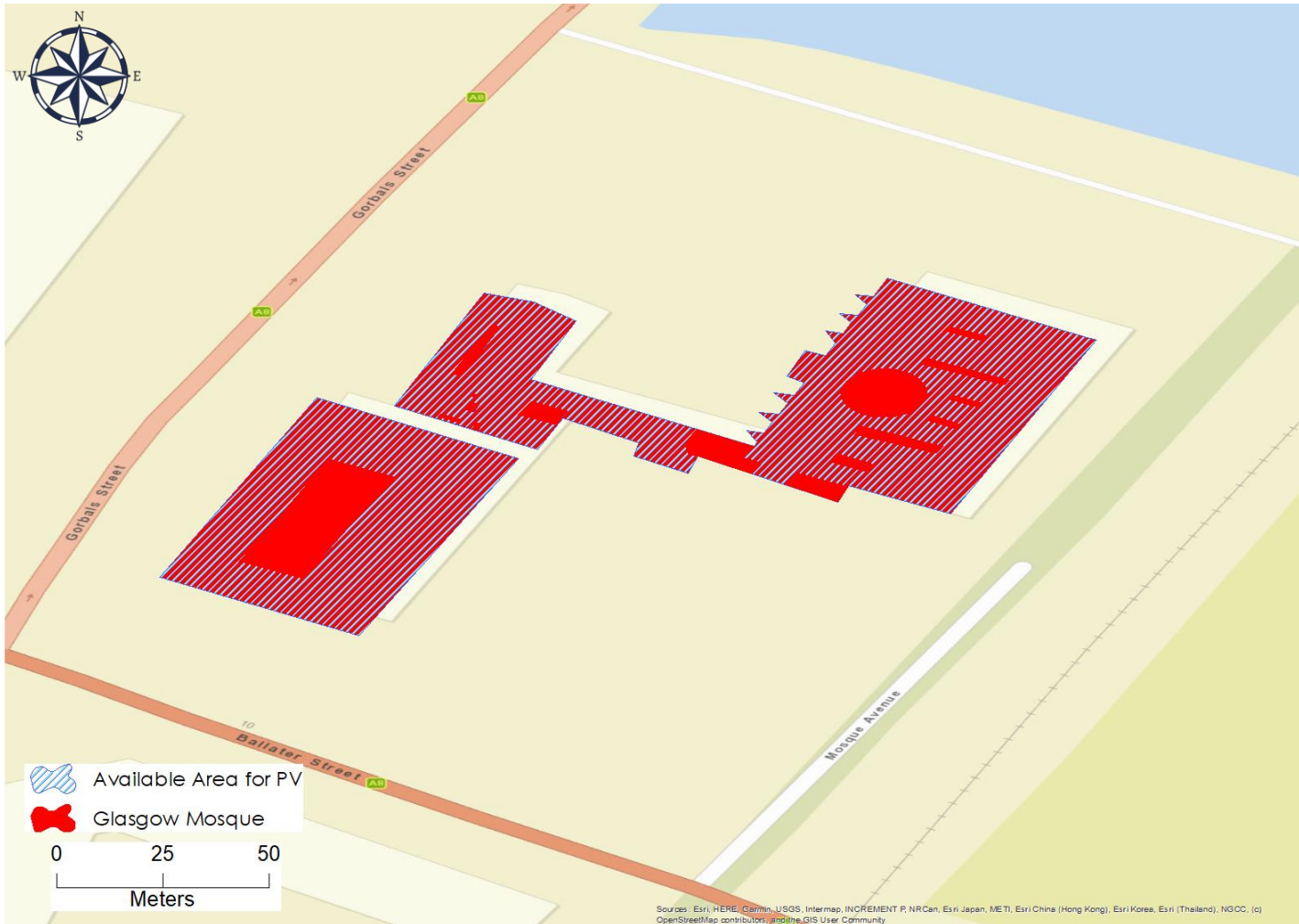

- The rooftop area of the mosque is : **3,600** m²
- Total Area available for installing PV system is : **3,030** m²

PV Design of Mosque's Rooftop

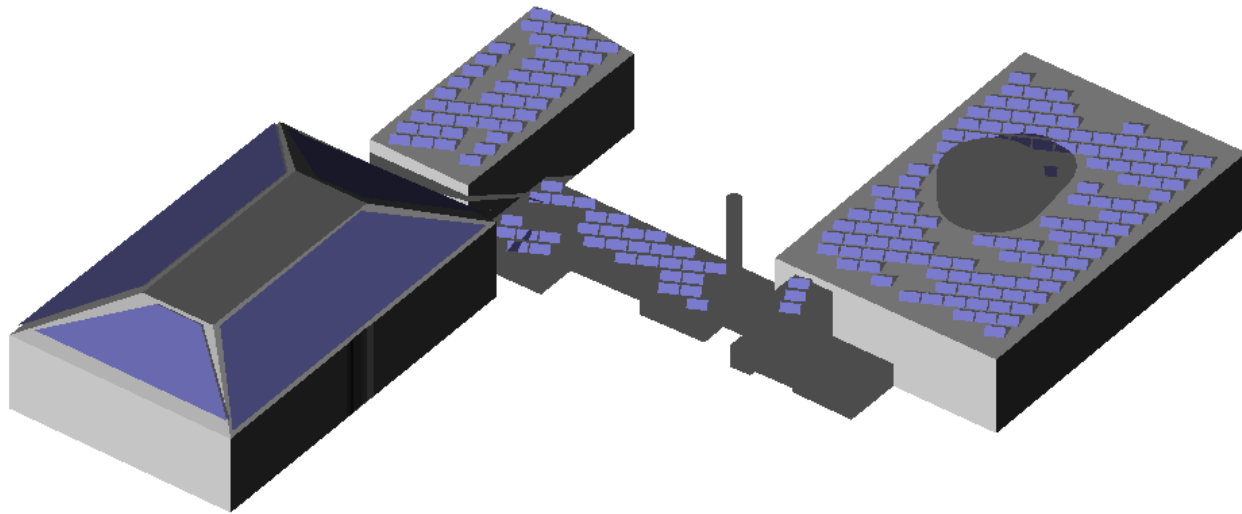

	Solar System Parameters
PV Module	Model: LR5-72 HPH 550 M
Manufacturer	Longi Solar
Nominal PV Power (kWp)	227
Total Number of modules	420
Total Area of Modules (m ²)	1074
Total Number of Sheds	208
Inverter	Model: SUN-2000
Manufacturer	Huawei Technologies
Nominal Inverter Power (kWac)	208
System Production	
Total Produced Energy (MWh/year)	191.1
System Performance Ratio (%)	85
System Cost	\$227,000

Economic Benefits

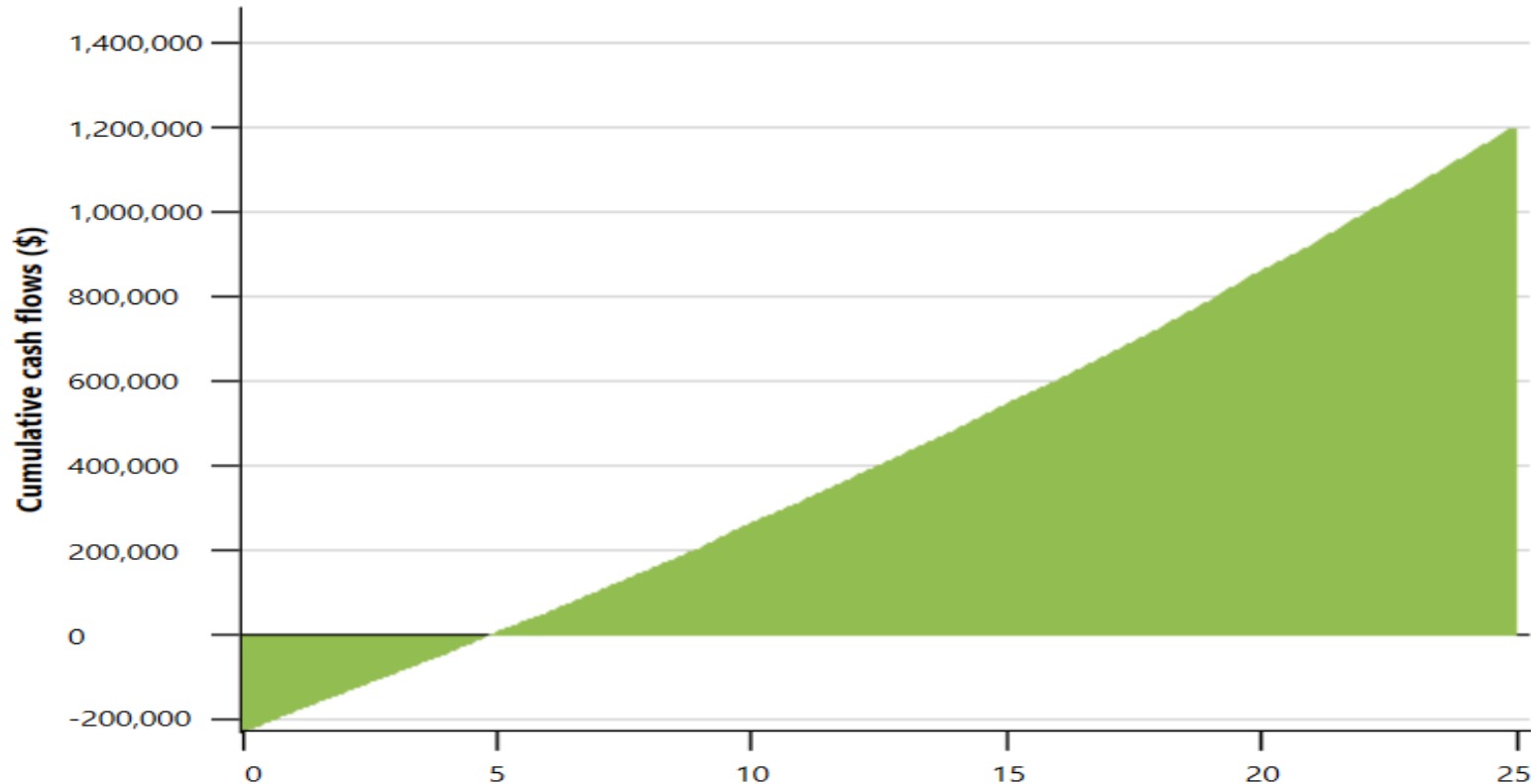

- Total Initial Cost = **\$227,000**
(Considering 1000 \$ /KWp - Ref: RETScreen)
- O&M Cost = **\$2,270/yr**
(Considering 10 \$ /KWp/yr - Ref: RETScreen)
- Savings = **\$43,630/yr**
(0.24\$/kWh in UK- Ref: Global Petrol Prices)
- NPV = **\$287,600**
- IRR = **21.3%**
- Simple payback = **5.2 yr**
- Benefit-Cost Ratio = **2.3**

Potential Jobs Created

Source: UNEP/ILO/IOE/ITUC, 2008.



2 - 3

Average employment (jobs per megawatt of solar photovoltaic system) over life of facility including manufacturing, construction, installation and operation & maintenance [ranges between 6.96 and 11.01 per MW](#)

Environmental Benefits

According to [RETScreen software](#), the GHG emission for 1 kWh is **0.245** kgCO₂/kWh. Referring to the energy produced by PV system which is around **0.191** GWh, the gross annual GHG emission reduction CO₂ is **43.5** tCO₂/yr would be equivalent to:



8 cars and light trucks not used per year

18,680 Liters of gasoline not consumed

41 Households reducing energy by 100%

15 Tonnes of waste recycled

4 Hectares of forest absorbing carbon

Additional Benefits

Source: RETScreen

Coverage of Energy Demand

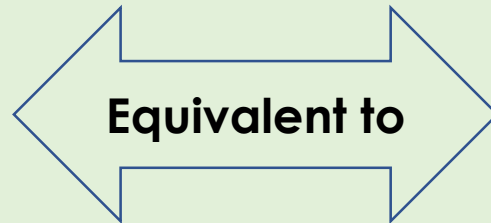
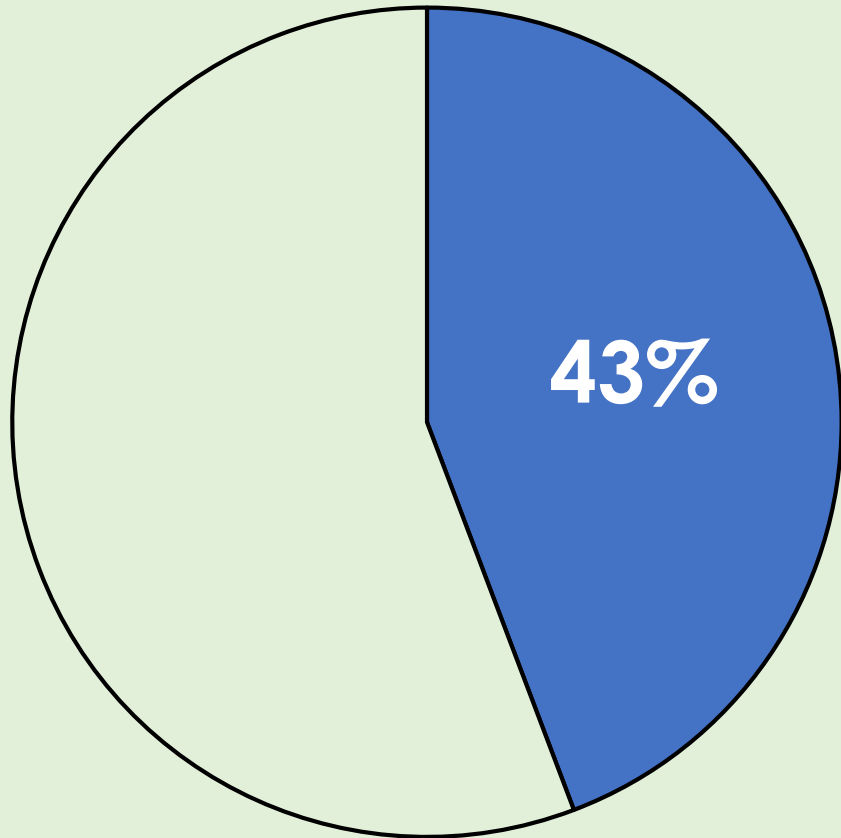

=

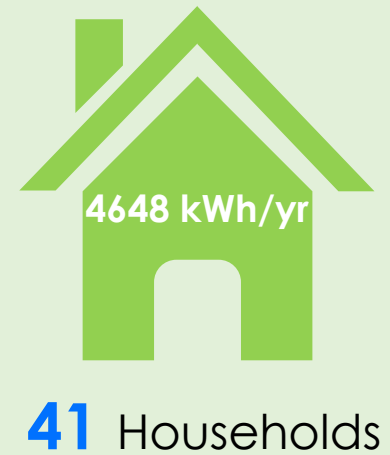

The yearly average consumption of a religious building is **120 kWh/m²**

3- Al Azhar Mosque

Preliminary Solar Energy Assessment

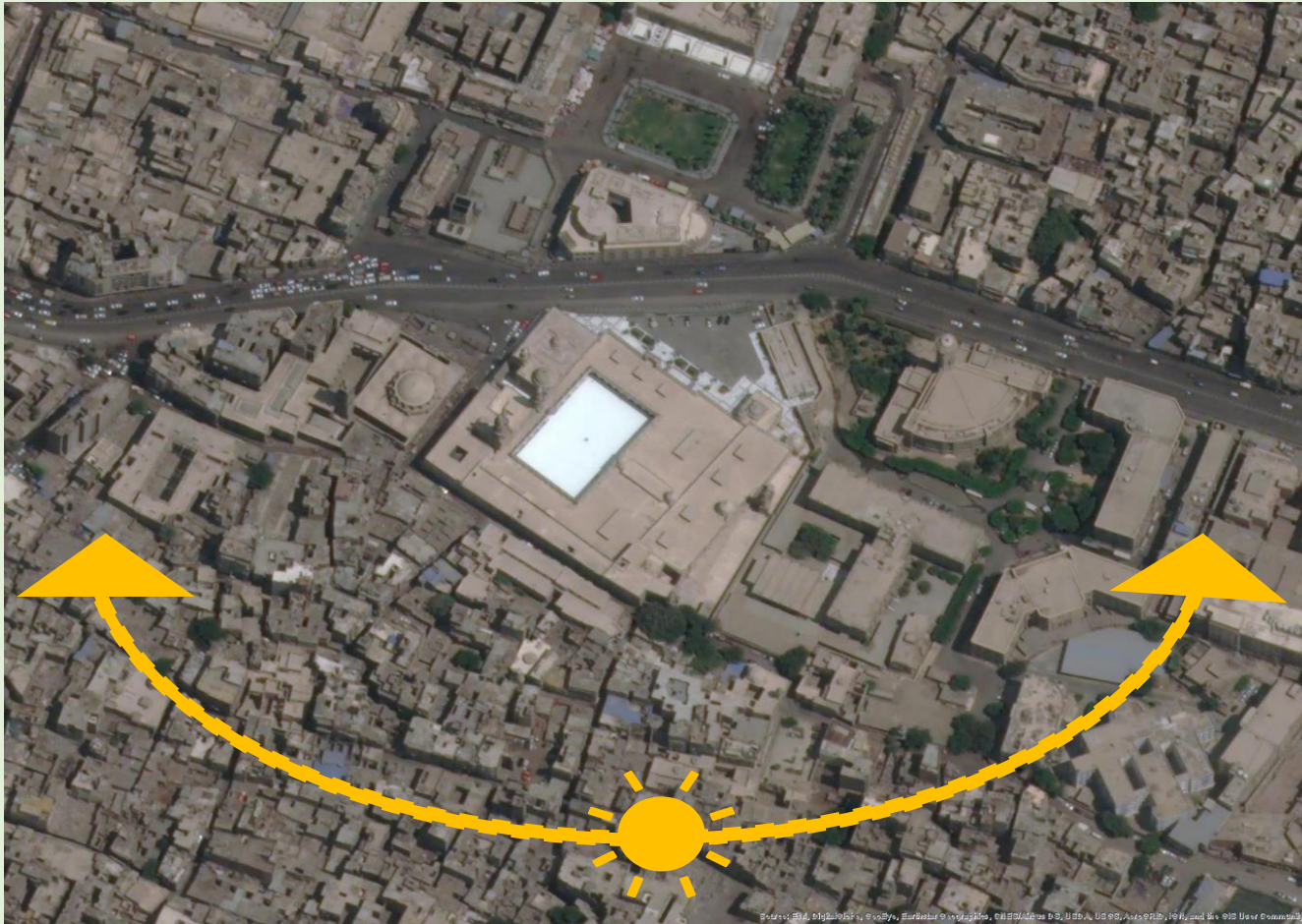

This mosque is located in Cairo, Egypt.
(30°02'46.0"N 31°15'44.8"E)

The optimal tilt angle of PV module is 26° and azimuth is south facing.

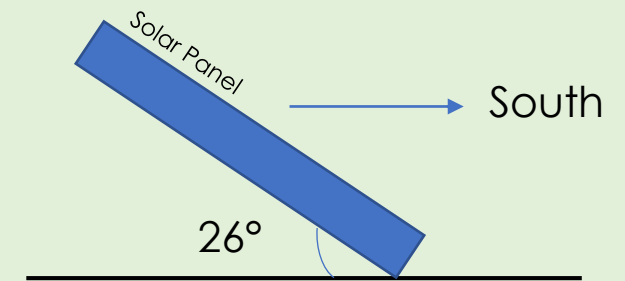

Source: Global Solar Atlas

Preliminary Solar Energy Assessment

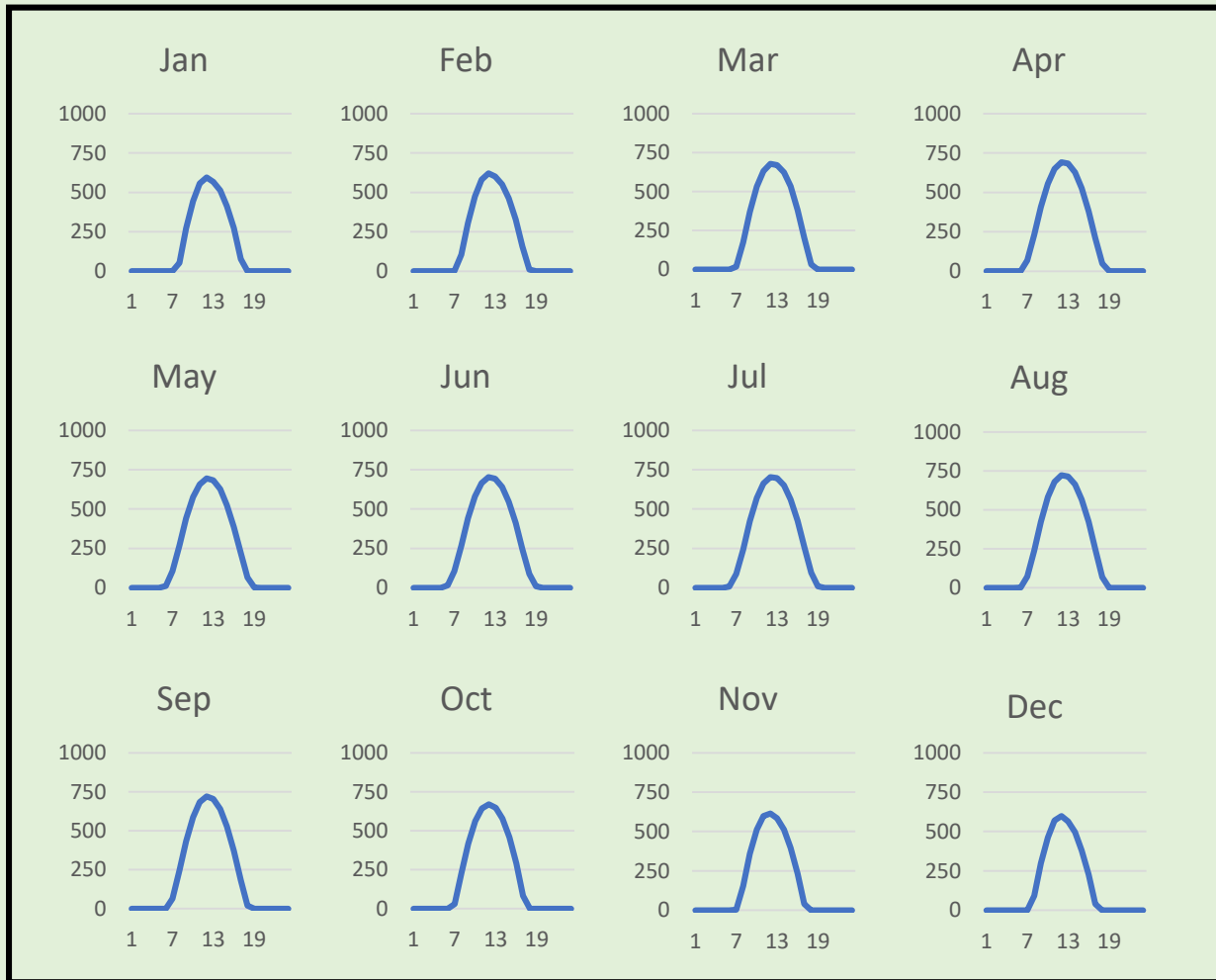

Average hourly profiles for each month
Total photovoltaic power output [Wh]

Total Photovoltaic Power Output per year
= 1731 kWh/kWp

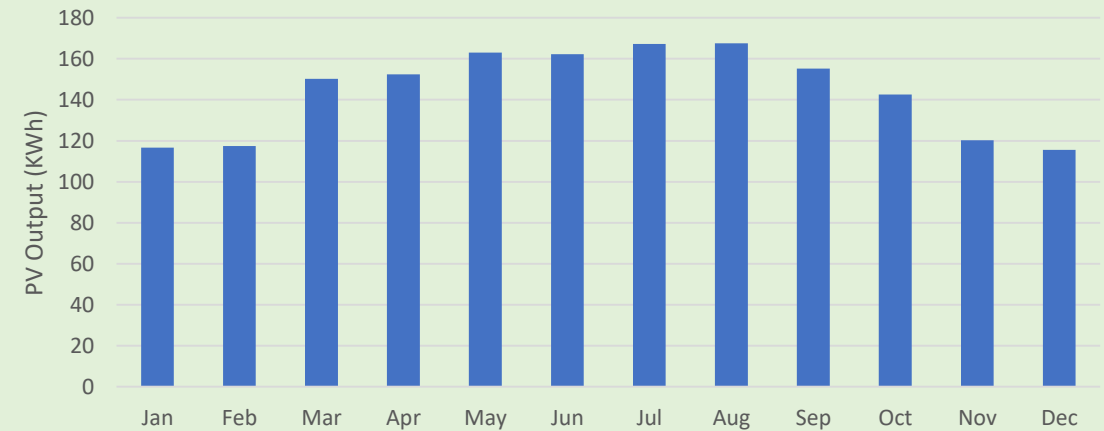

Monthly Averages

Total photovoltaic power output [kWh]

The figures show the hourly and monthly operation of 1 kWp PV system installed at Cairo. We can conclude that the energy production ranges between 115 kWh/yr and 167 kWh/yr, with high potential for solar energy production.

Data source : Global Solar Atlas

Preliminary Solar Site Assessment

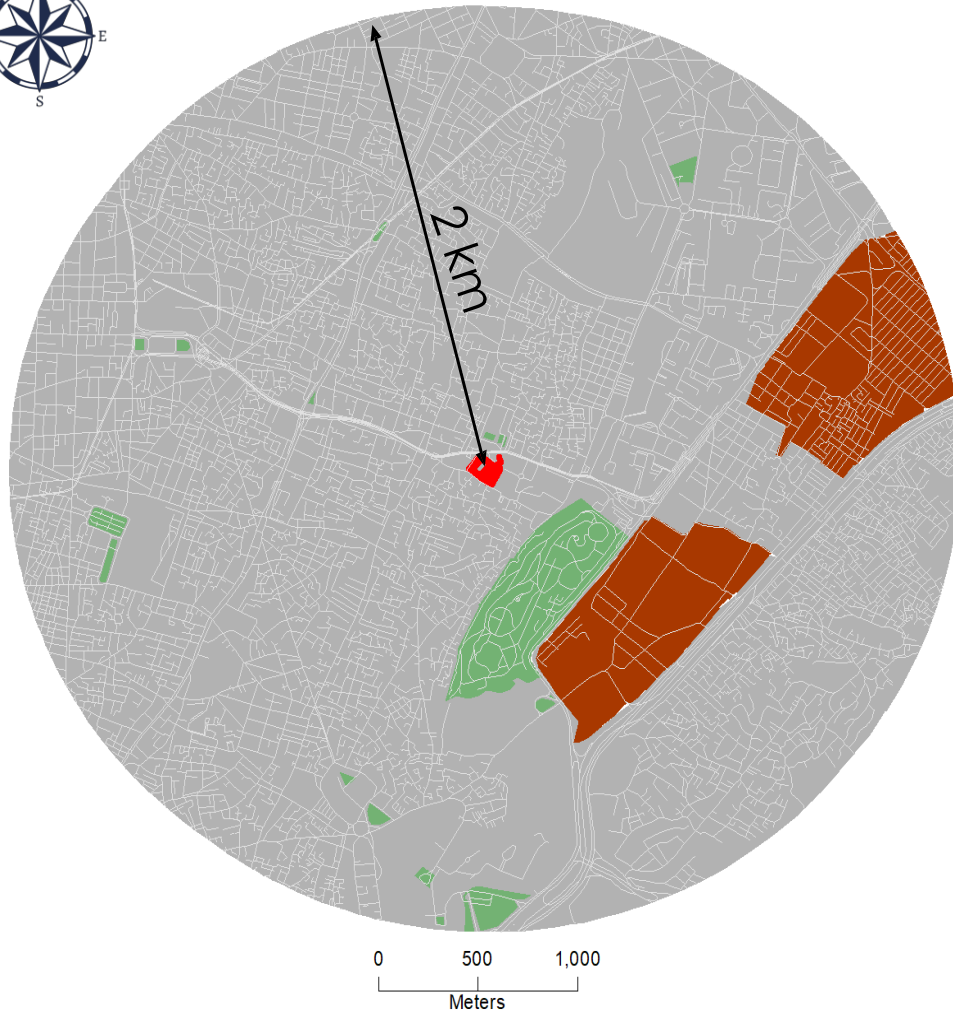

Land Use Type

- Roads
- Al Azhar Mosque
- Green Area
- cemetery
- Urban Area

The adjacent map shows the land use type at radius 2 km from the mosque. Al Azhar mosque is located in a high density urban area with a few green plots.

Preliminary Solar Site Assessment

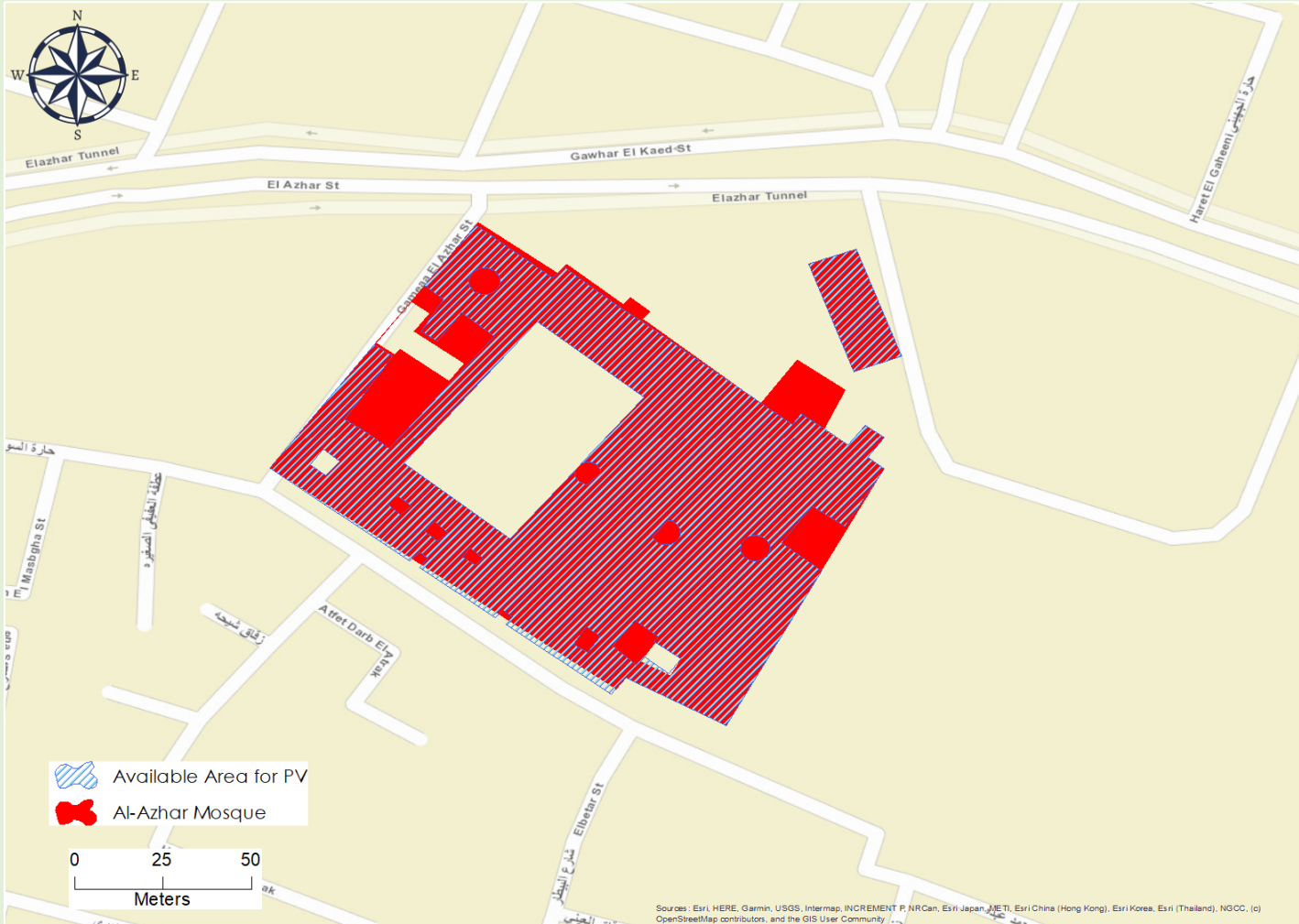

- The rooftop area of the mosque is: **9,700** m²
- Total area available for installing PV system is : **8,510** m²

PV Design of Mosque's Rooftop

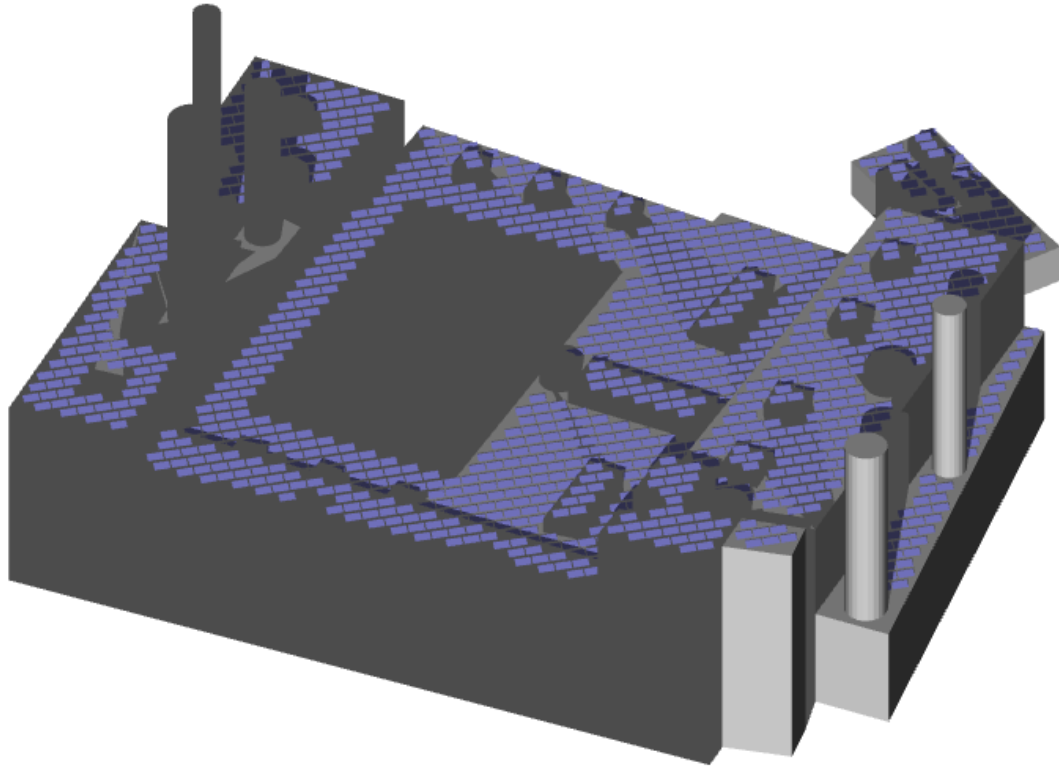

	Solar System Parameters
PV Module	Model: LR5-72 HPH 540 M
Manufacturer	Longi Solar
Nominal PV Power (kWp)	599
Total Number of modules	1110
Total Area of Modules (m ²)	2837
Total Number of Sheds	1110
Inverter	Model: PVMC-45-0540
Manufacturer	LTi REEnergy
Nominal Inverter Power (kWac)	540
System Production	
Total Produced Energy (MWh/year)	914
System Performance Ratio (%)	74
System Cost	\$599,000

Economic Benefits

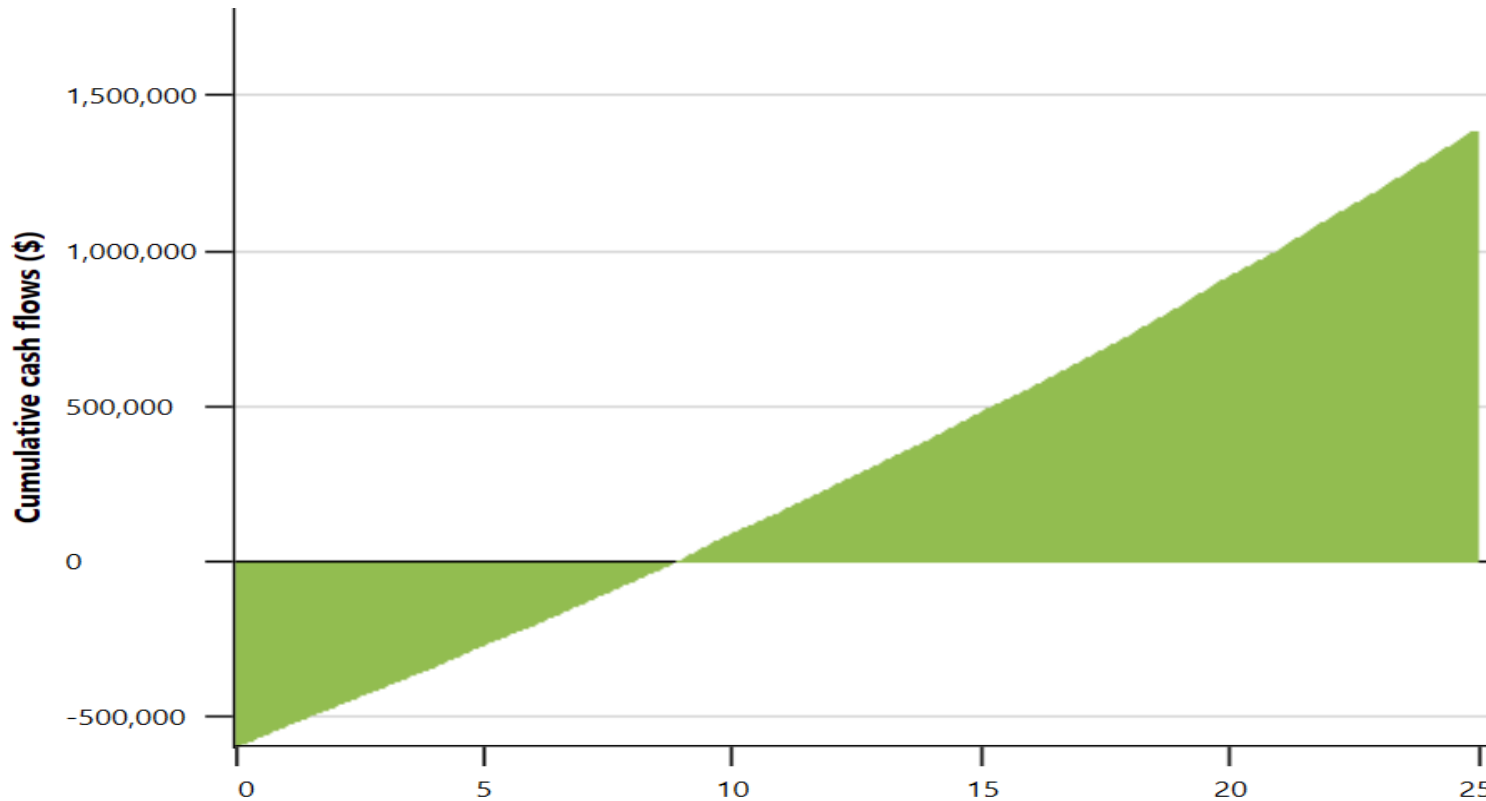

- Total Initial Cost = **\$599,000**
(Considering 1000 \$ /KWp - Ref: RETScreen)
- O&M Cost = **\$5,990/yr**
(Considering 10 \$ /KWp/yr - Ref: RETScreen)
- Savings = **\$60,710/yr**
(0.073\$/kWh in Egypt- Ref: Global Petrol Prices)
- NPV = **\$118,500**
- IRR = **11.2%**
- Simple payback = **9.8 yr**
- Benefit-Cost Ratio = **1.2**

Potential Jobs Created

Source: UNEP/ILO/IOE/ITUC, 2008.



4 - 7

Average employment (jobs per megawatt of solar photovoltaic system) over life of facility including manufacturing, construction, installation and operation & maintenance [ranges between 6.96 and 11.01 per MW](#)

Environmental Benefits

According to [RETScreen software](#), the GHG emission for 1 kWh is **0.522** kgCO₂/kWh. Referring to the energy produced by PV system which is around **0.914** GWh, the gross annual GHG emission reduction CO₂ is **444** tCO₂/yr would be equivalent to:



81 cars and light trucks not used per year

190,593 Liters of gasoline not consumed

377 Households reducing energy by 100%

153 Tonnes of waste recycled

41 Hectares of forest absorbing carbon

Additional Benefits

Source: RETScreen

Coverage of Energy Demand

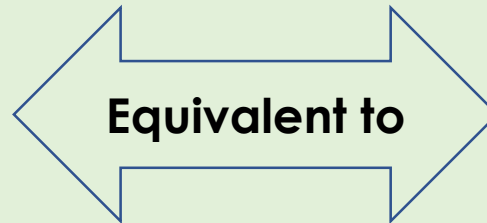
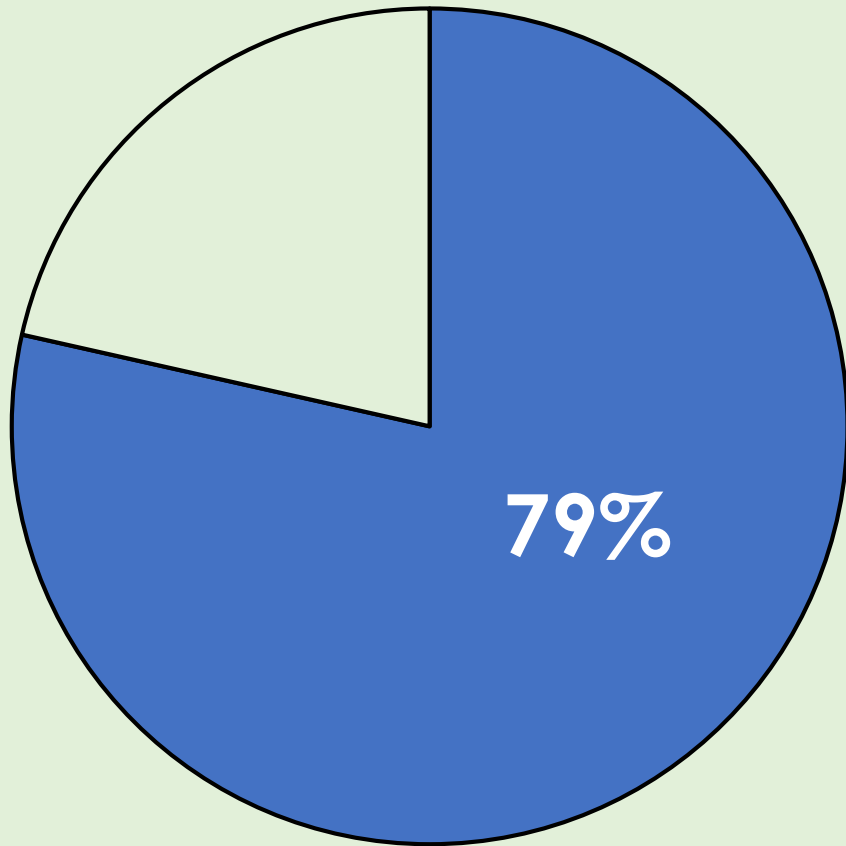

1510 Citizens

=

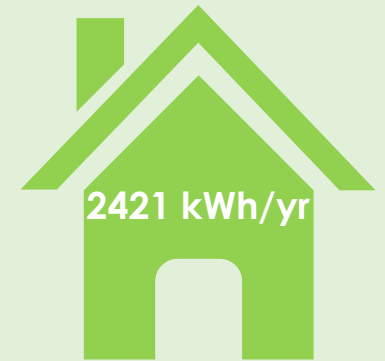

377 Households

The yearly average consumption of a religious building is **120** kWh/m²

4- Grand Jamia Mosque

Preliminary Solar Energy Assessment

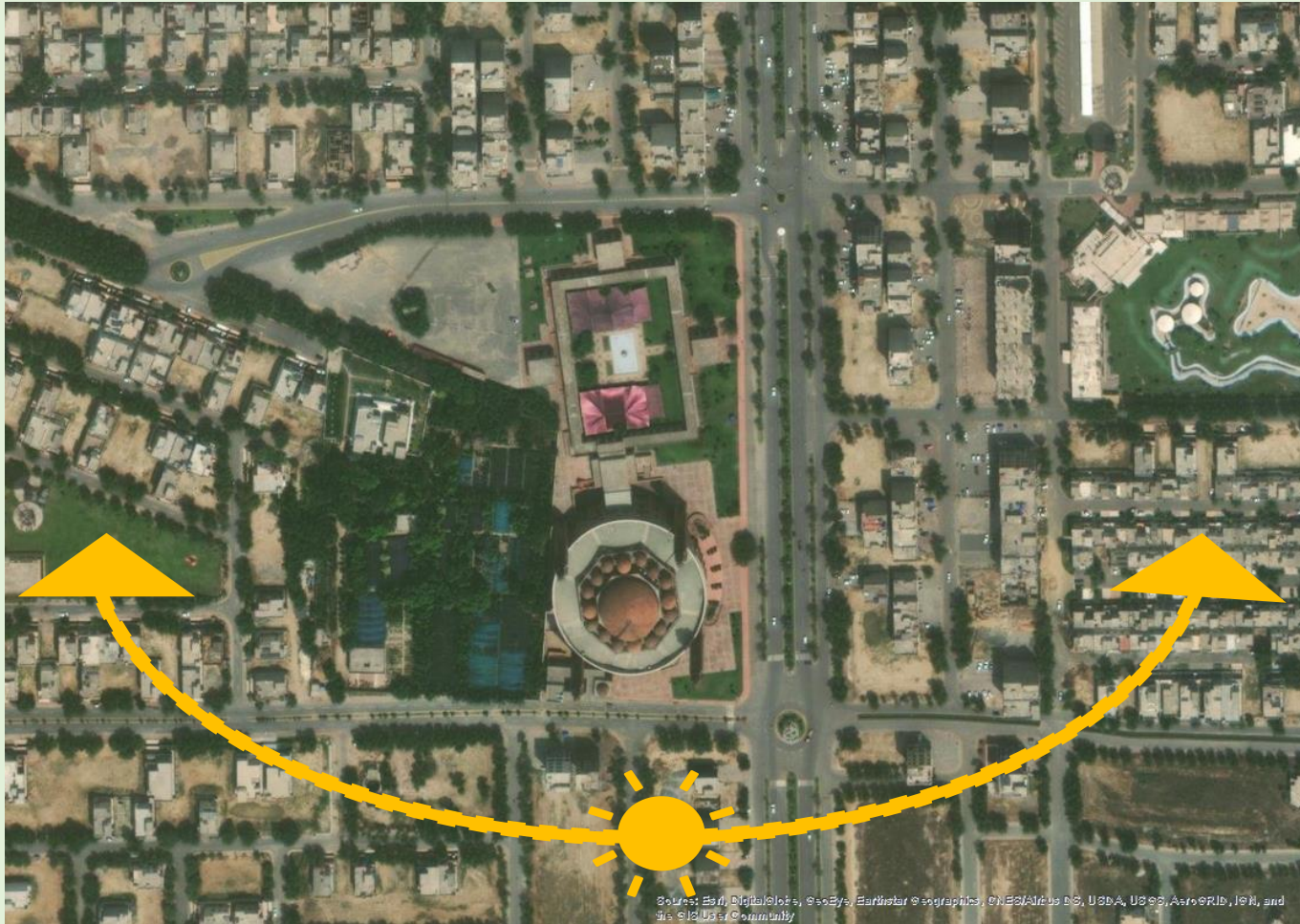

This mosque is located in Lahore, Pakistan. (31°22'08.4"N 74°11'07.6"E)

The optimal tilt angle of PV module is 28° and azimuth is south facing.

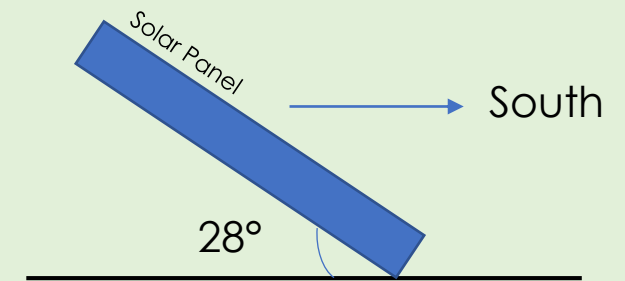

Source: Global Solar Atlas

Preliminary Solar Energy Assessment

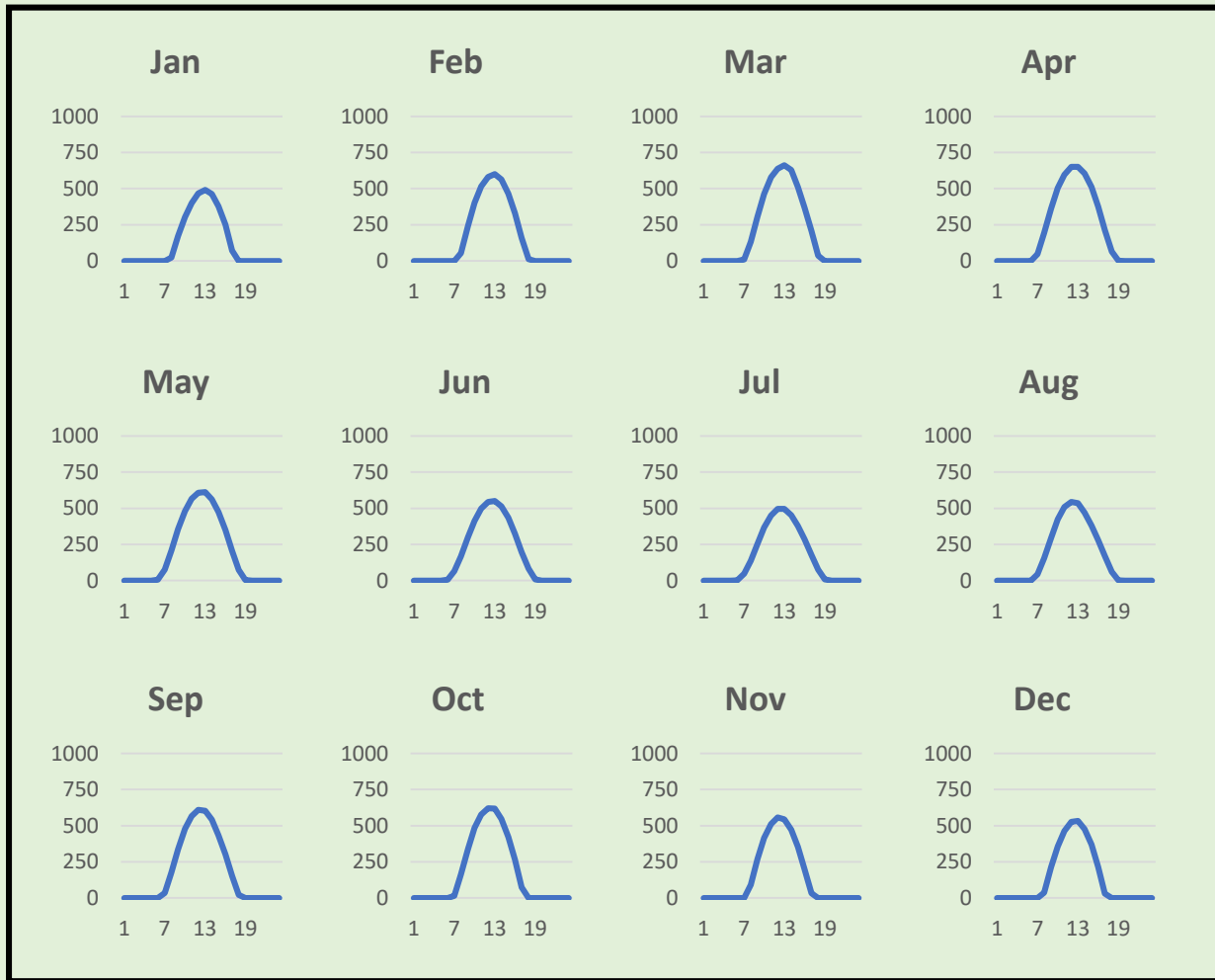

Average hourly profiles for each month
Total photovoltaic power output [Wh]

Total Photovoltaic Power Output per year
= 1443 kWh/kWp

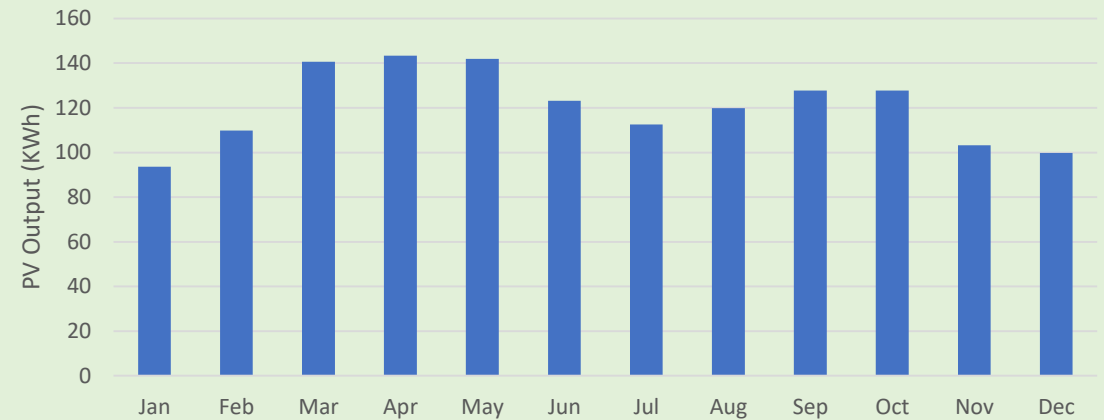

Monthly Averages

Total photovoltaic power output [kWh]

The figures show the hourly and monthly operation of 1 kWp PV system installed at the city of Lahore. We can conclude that the energy production ranges between 93 kWh/yr and 143 kWh/yr, with moderate potential of solar energy.

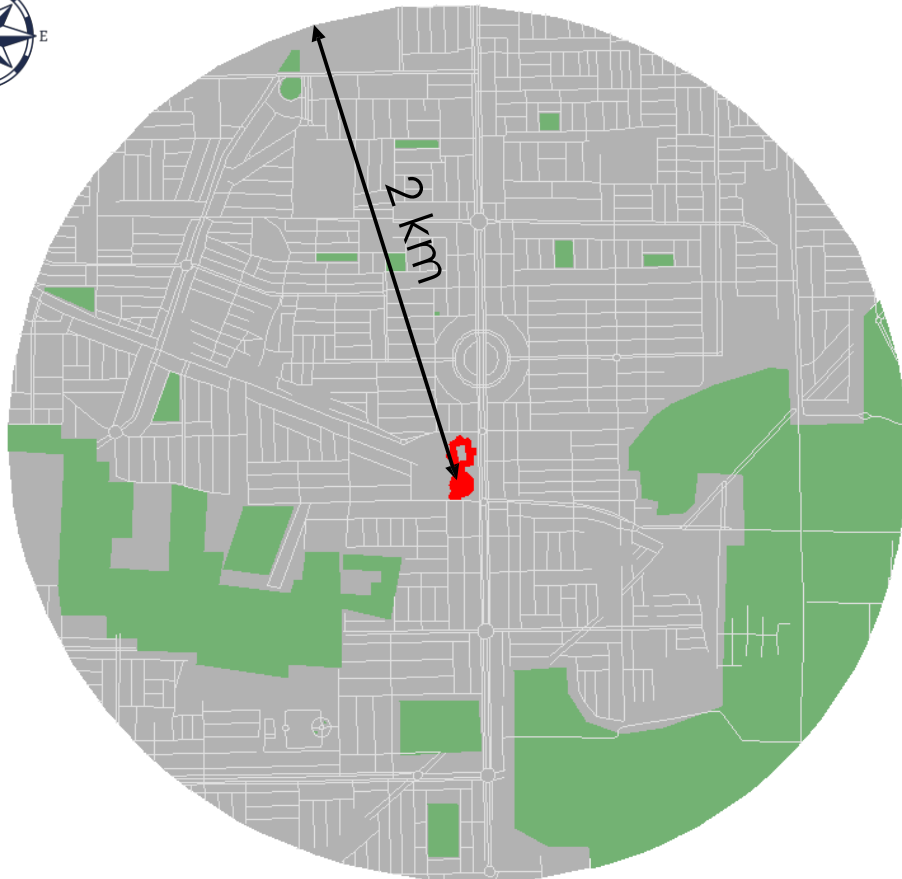

Data source : Global Solar Atlas

Preliminary Solar Site Assessment



0 500 1,000
Meters

Land Use Type

- Roads
-  Grand Jamia Mosque
-  Green Area
-  Urban Area

The adjacent map shows the land use at radius 2 km from the mosque. Grand Jamia mosque is located in a high density urban area with large green areas in the vicinity.

Preliminary Solar Site Assessment

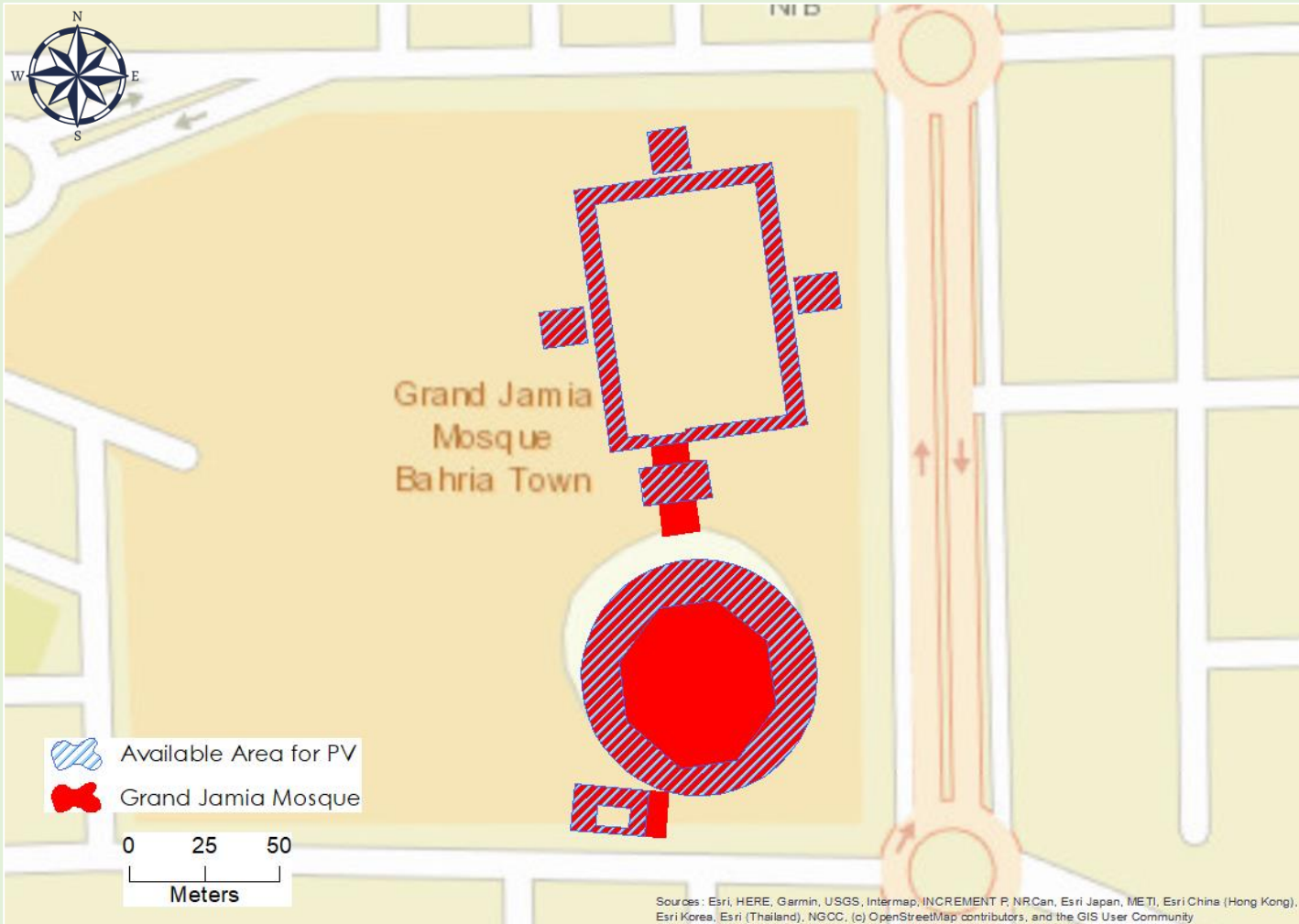

- The rooftop area of the mosque is: **7,930** m²
- Total area available for installing a PV system is : **5,430** m²

PV Design of Mosque's Rooftop

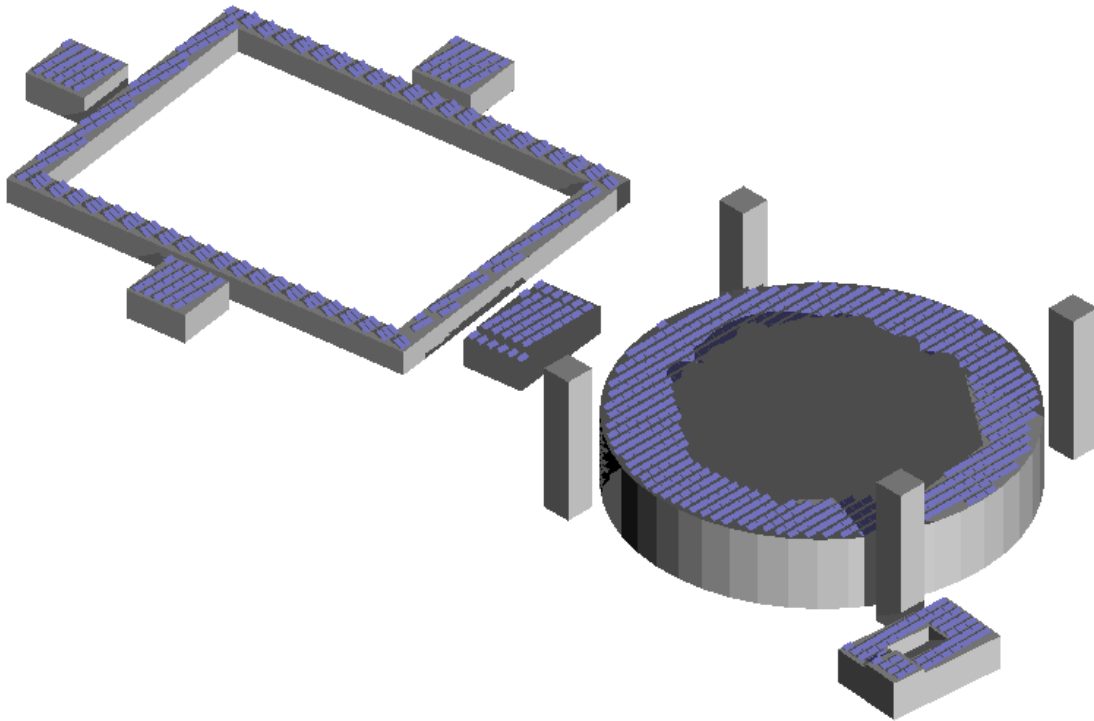

	Solar System Parameters
PV Module	Model: LR5-72 HPH 550 M
Manufacturer	Longi Solar
Nominal PV Power (kWp)	446
Total Number of modules	825
Total Area of Modules (m ²)	2109
Total Number of Sheds	825
Inverter	Model: Ingecon Sun 400TL M320 DC Indoor
Manufacturer	Ingeteam
Nominal Inverter Power (kWac)	408
System Production	
Total Produced Energy (MWh/year)	637
System Performance Ratio (%)	80
System Cost	\$446,000

Economic Benefits

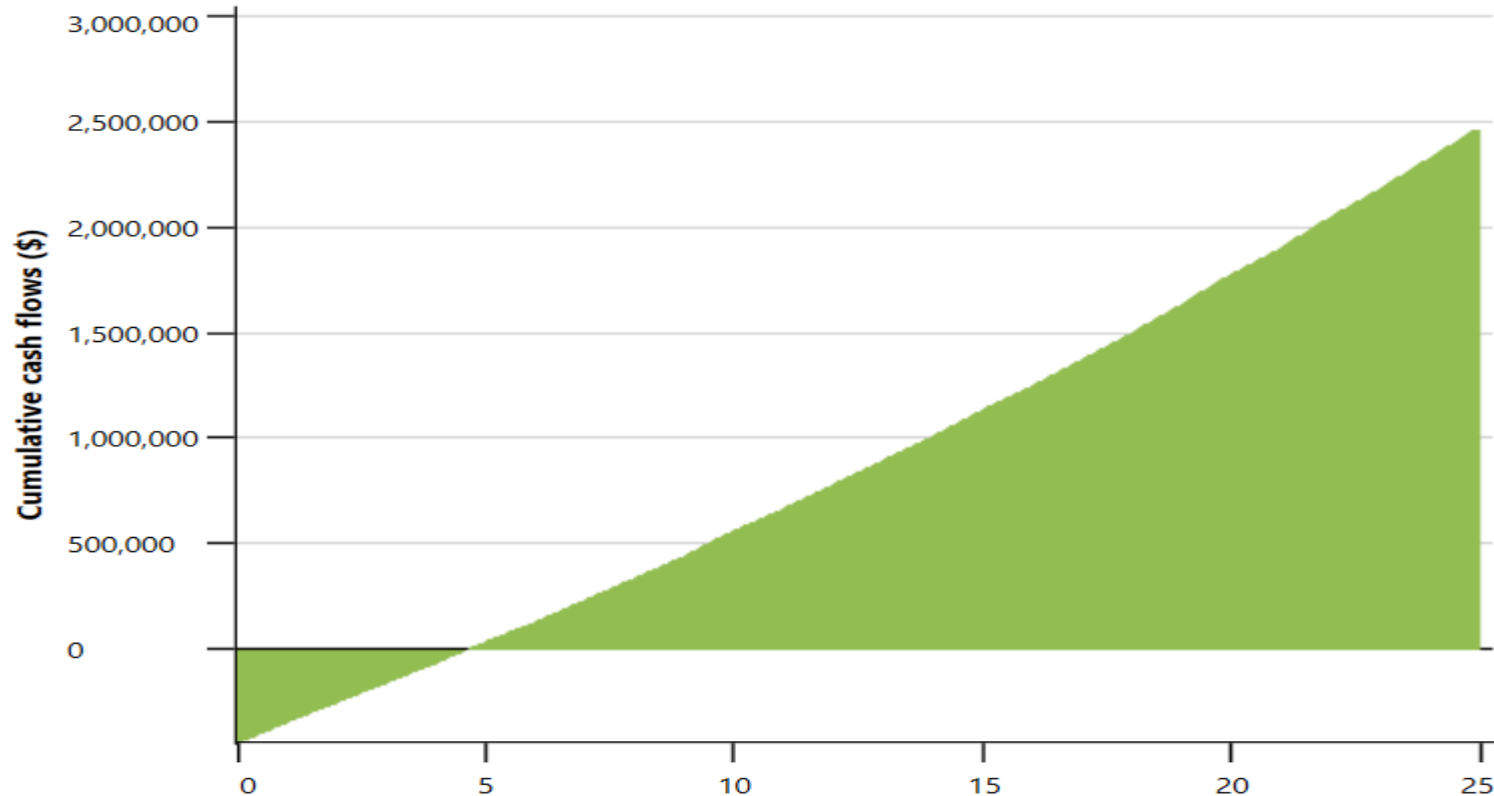

- Total Initial Cost = **\$446,000**
(Considering 1000 \$ /KWp - Ref: RETScreen)
- O&M Cost = **\$4,460/yr**
(Considering 10 \$ /KWp/yr - Ref: RETScreen)
- Savings = **\$89,140/yr**
(0.147\$/kWh in Pakistan- Ref: Global Petrol Prices)
- NPV = **\$606,000**
- IRR = **22.2%**
- Simple payback = **5 yr**
- Benefit-Cost Ratio = **2.4**

Potential Jobs Created

Source: UNEP/ILO/IOE/ITUC, 2008.



3 - 5

Average employment (jobs per megawatt of solar photovoltaic system) over life of facility including manufacturing, construction, installation and operation & maintenance [ranges between 6.96 and 11.01 per MW](#)

Environmental Benefits

According to [RETScreen software](#), the GHG emission for 1 kWh is **0.421** kgCO₂/kWh. Referring to the energy produced by PV system which is around **0.637** GWh, the gross annual GHG emission reduction CO₂ is **249** tCO₂/yr would be equivalent to:



OR



OR



OR



OR



46 and light trucks
not used per year

107,181 Liters
of gasoline not
consumed

327 Households
reducing energy
by 100%

86 Tonnes of
waste recycled

22.9 Hectares of
forest absorbing
carbon

Additional Benefits

Source: RETScreen

Coverage of Energy Demand

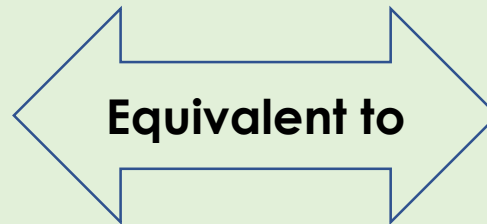
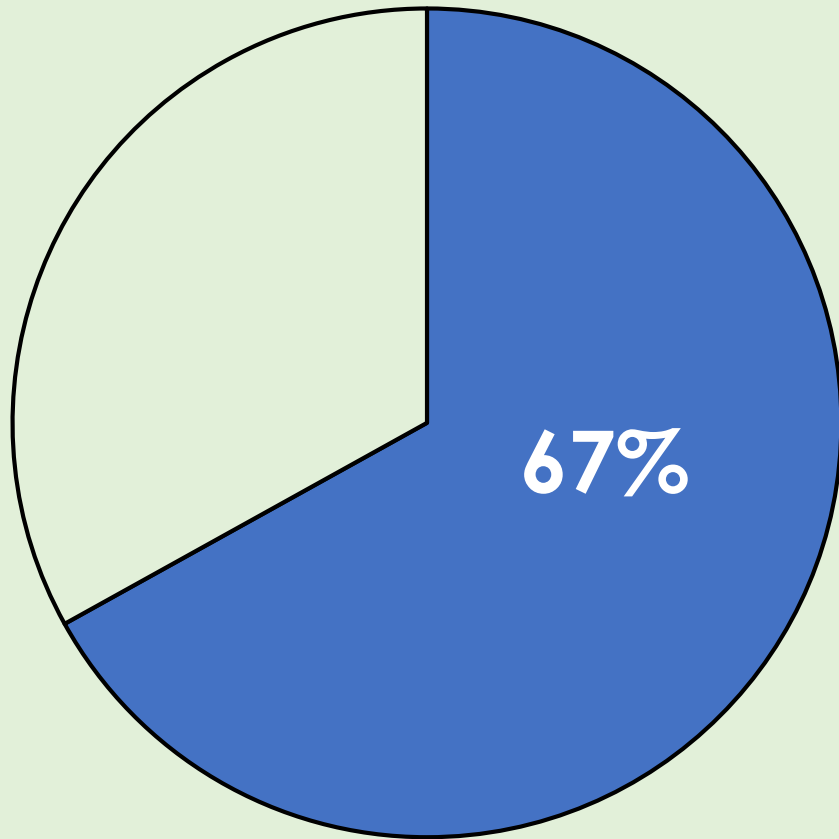

3481 Citizens

=

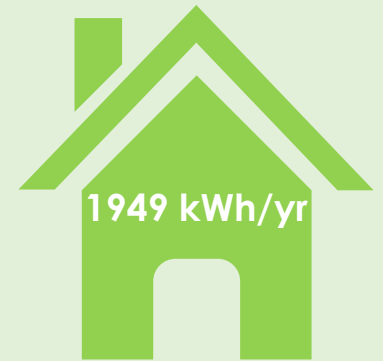

327 Households

The yearly average consumption of a religious building is **120** kWh/m²

5- Istiqlal Mosque

Preliminary Solar Energy Assessment



This mosque is located in Jakarta, Indonesia. ($6^{\circ}10'14.5''S$ $106^{\circ}49'52.9''E$)

The optimal tilt angle of PV module is 9° and azimuth is north facing.

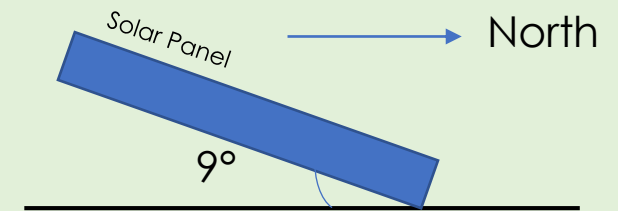

Source: Global Solar Atlas

Preliminary Solar Energy Assessment

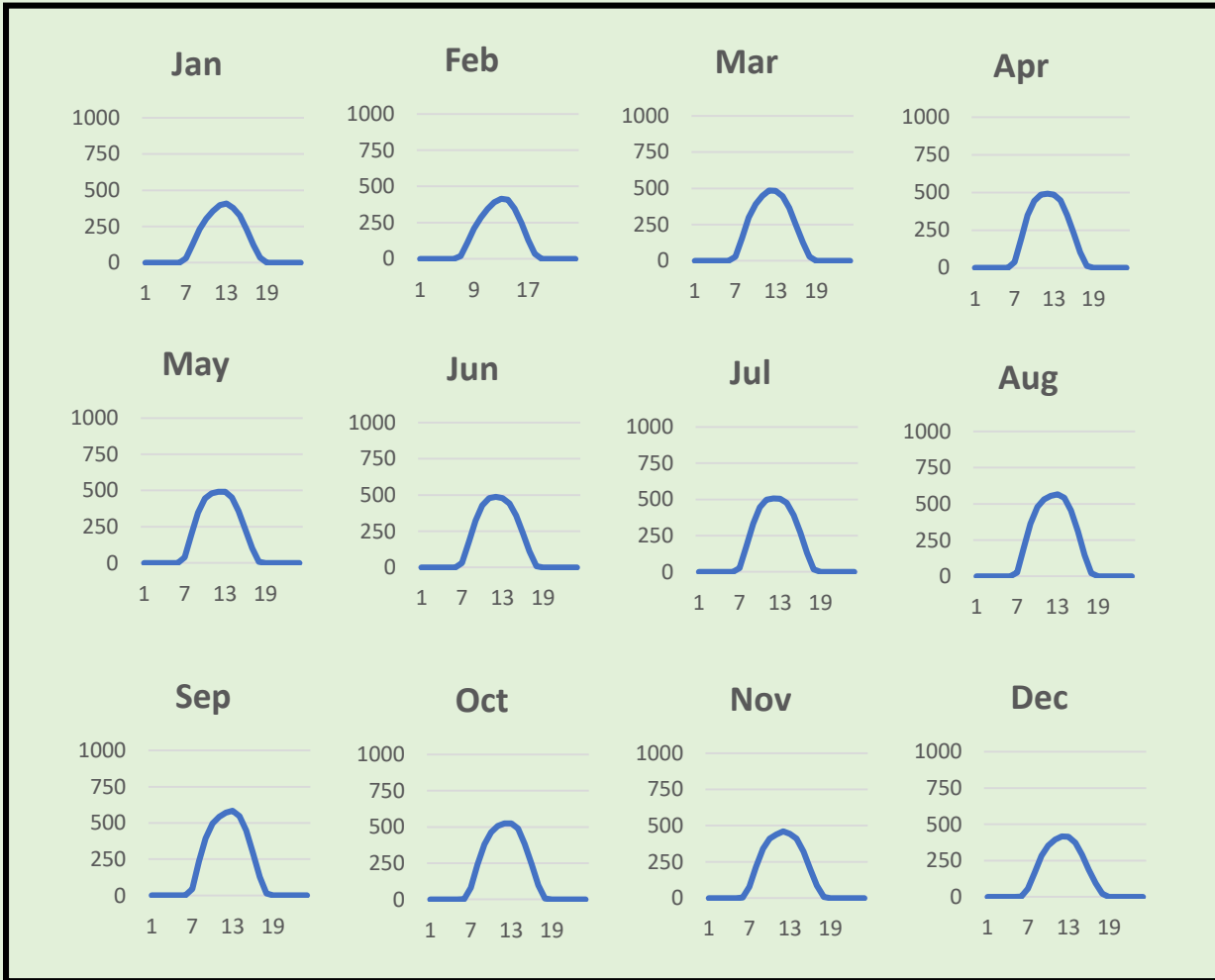

Average hourly profiles for each month
Total photovoltaic power output [Wh]

Total Photovoltaic Power Output per year
= 1306 kWh/kWp

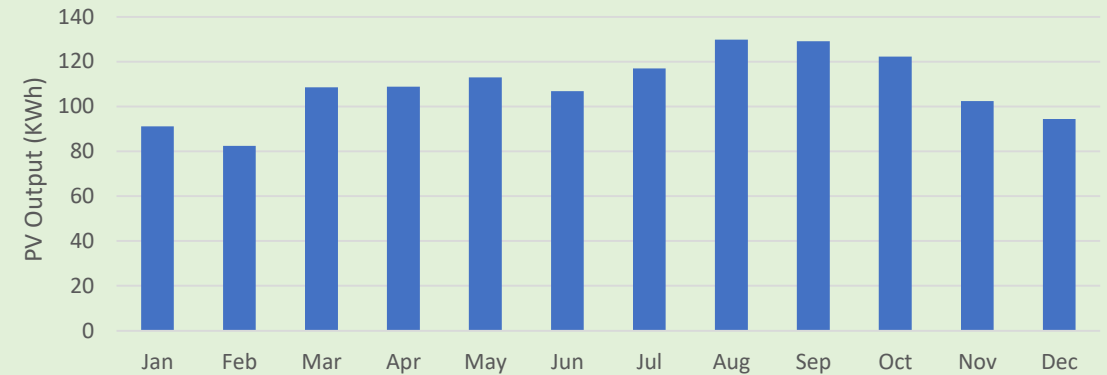

Monthly Averages
Total photovoltaic power output [kWh]

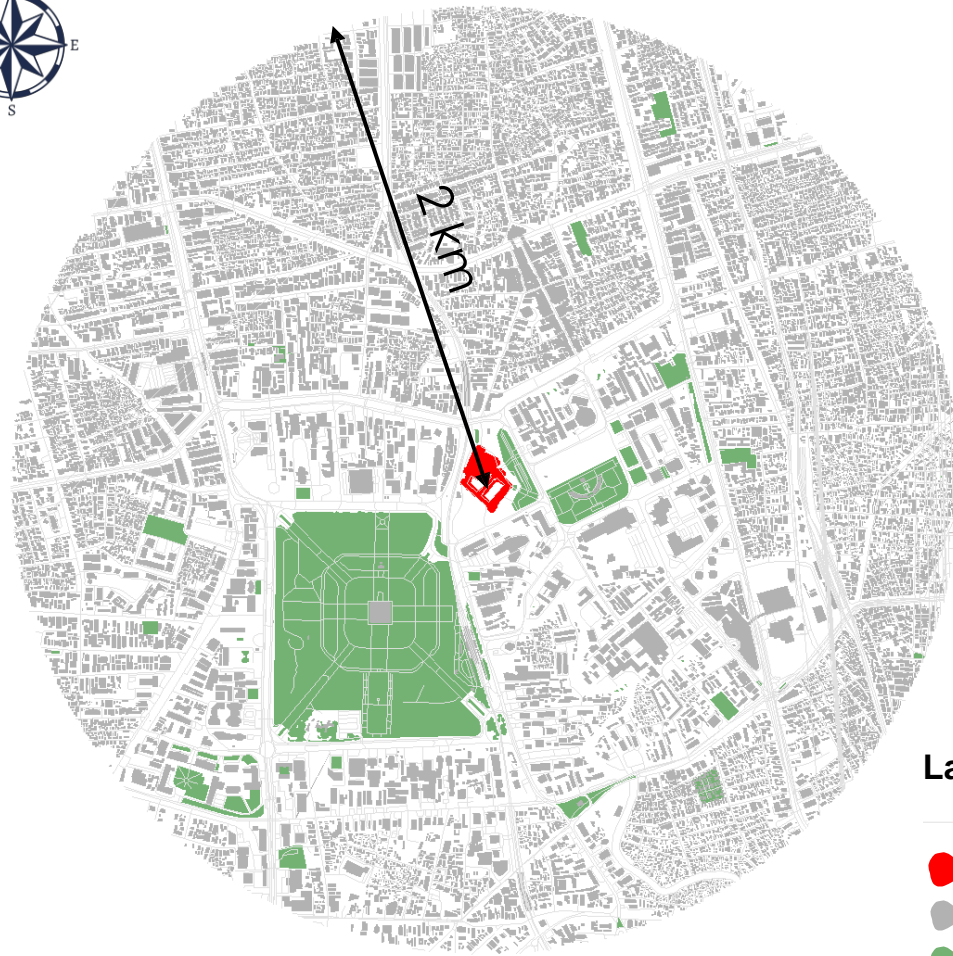

The figures show the hourly and monthly operation of 1 kWp PV system installed in Jakarta. We can conclude that the energy production ranges between 82 kWh/yr and 129 kWh/yr, with moderate potential for solar energy production.
Data source : Global Solar Atlas

Preliminary Solar Site Assessment



0 500 1,000
Meters

Land Use Type

- Roads
-  Istiqlal Mosque
-  Urban Area
-  Green Area

The adjacent map shows the land use type at radius 2 km from the mosque. Istiqlal mosque is located in a high density urban area with some green areas in the vicinity.

Preliminary Solar Site Assessment

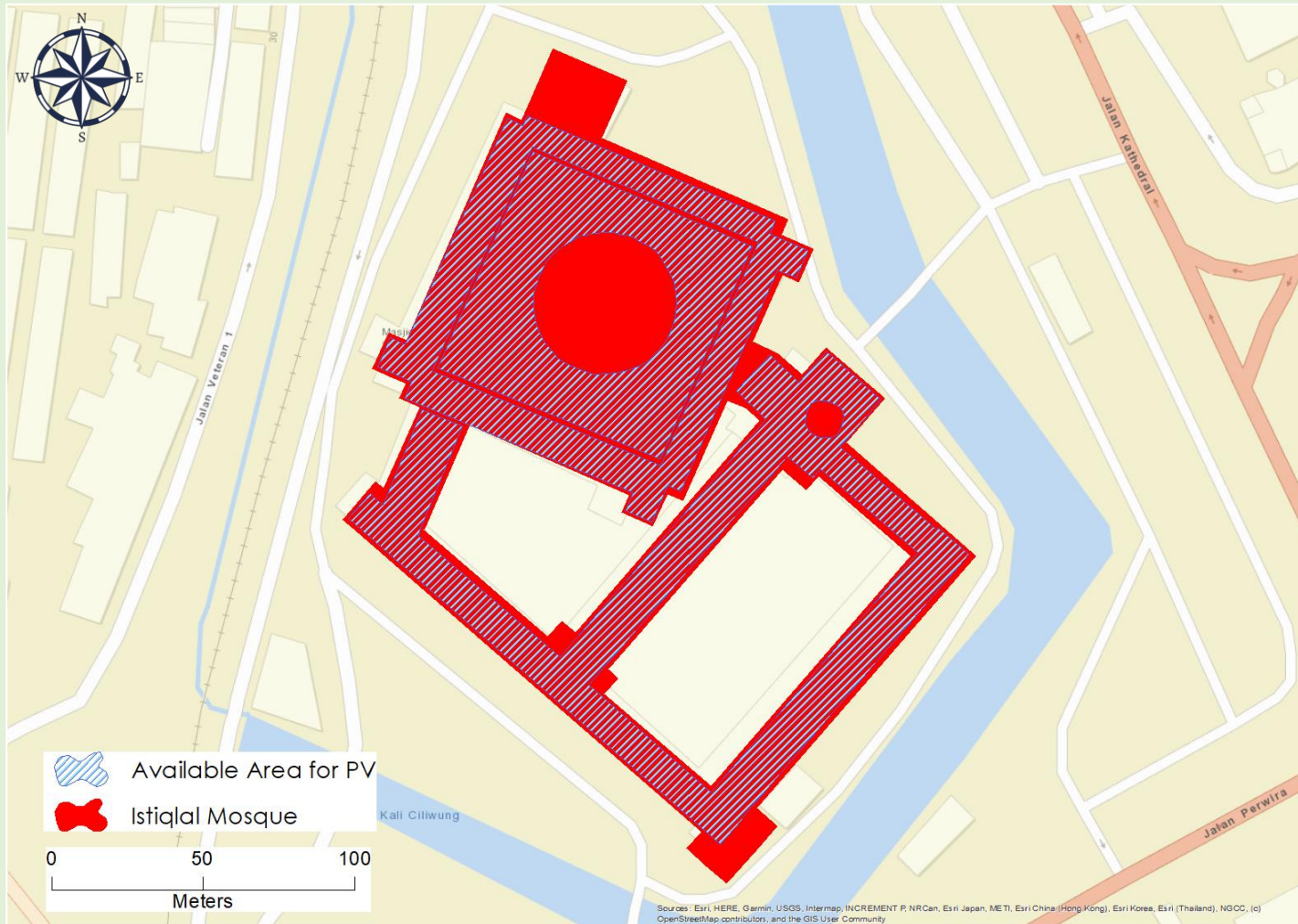

- The rooftop area of the mosque is: **20,200** m²
- Total area available for installing a PV system is : **14,600** m²

PV Design of Mosque's Rooftop

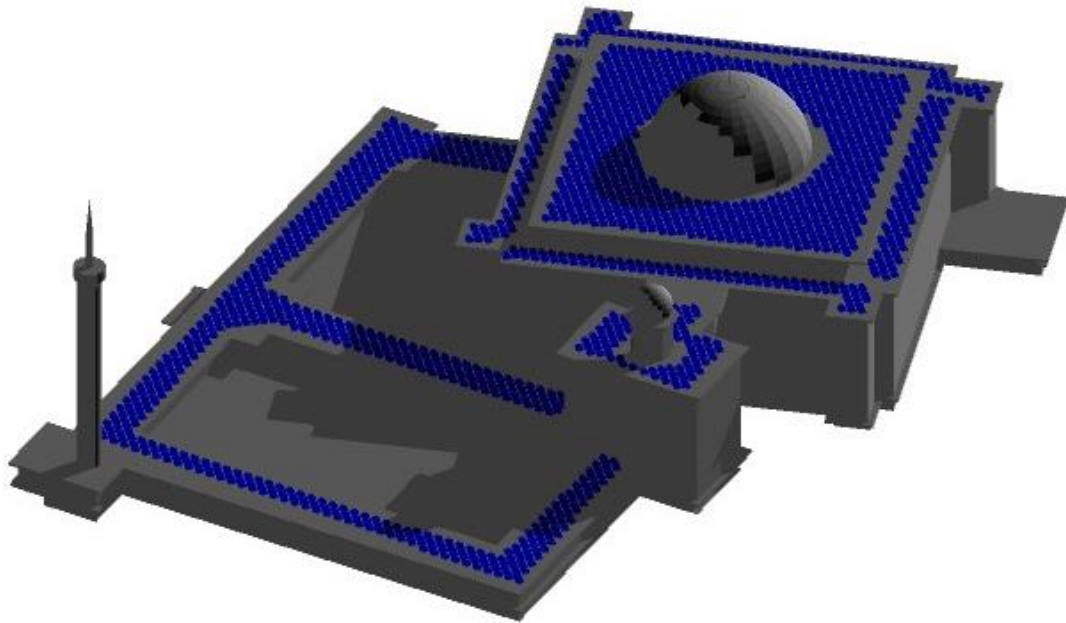

	Solar System Parameters
PV Module	Model: LR5-72 HPH 550 M
Manufacturer	Longi Solar
Nominal PV Power (kWp)	1019
Total Number of modules	1853 (17 in series , 109 in Parallel)
Total Area of Modules (m ²)	4736
Total Number of Sheds	1858
Inverter	Model: ULTRA-700.0-TL
Manufacturer	ABB
Nominal Inverter Power (kWac)	1000
System Production	
Total Produced Energy (MWh/year)	1441
System Performance Ratio (%)	80
System Cost	\$1,019,000

Economic Benefits

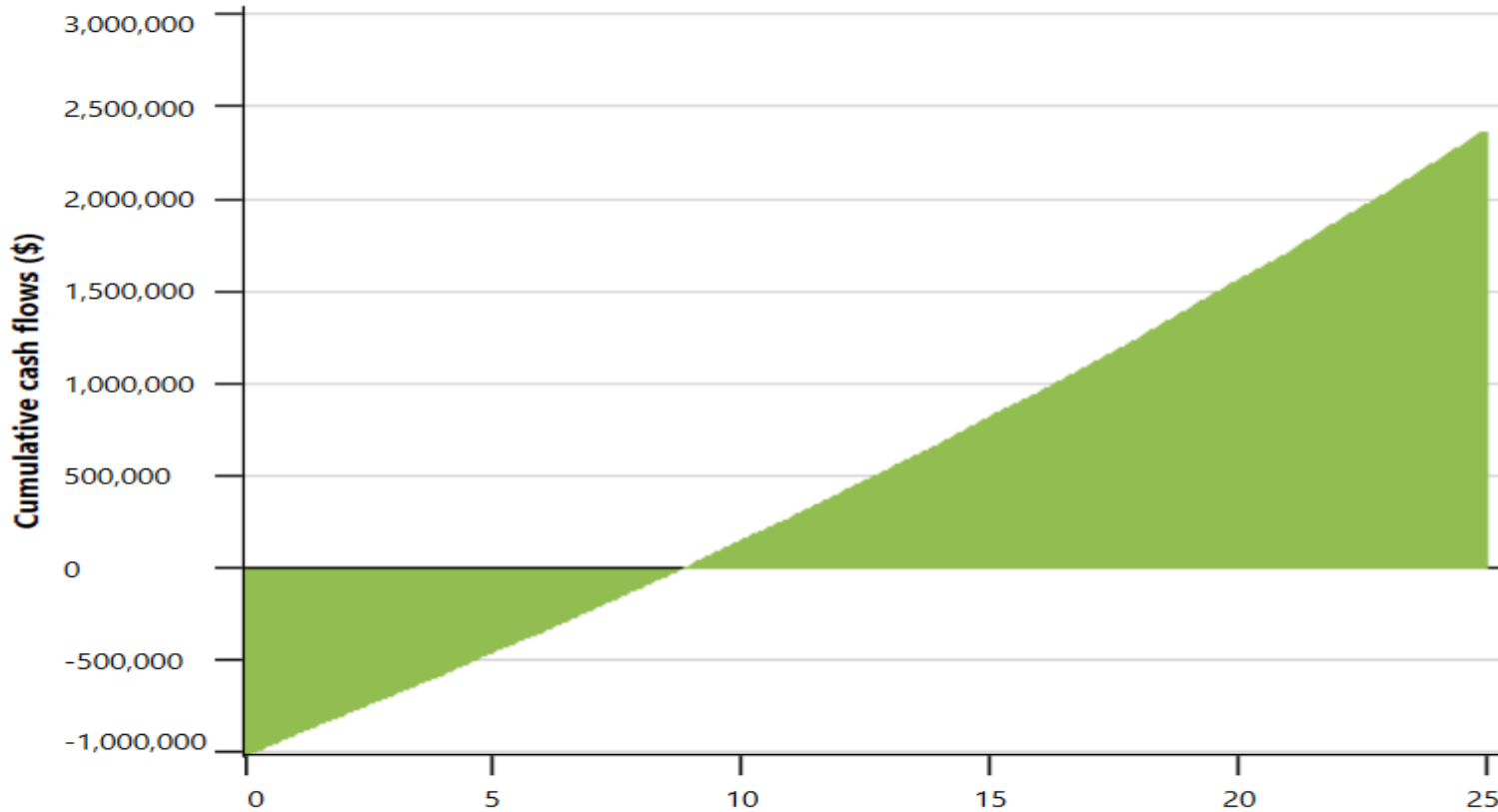

- Total Initial Cost = **\$1,019,000**
(Considering 1000 \$ /KWp - Ref: RETScreen)
- O&M Cost = **\$10,190/yr**
(Considering 10 \$ /KWp/yr - Ref: RETScreen)
- Savings = **\$103,710/yr**
(0.079\$/kWh in Indonesia- Ref: Global Petrol Prices)
- NPV = **\$204,500**
- IRR = **11.2%**
- Simple payback = **9.8 yr**
- Benefit-Cost Ratio = **1.2**

Potential Jobs Created

Source: UNEP/ILO/IOE/ITUC, 2008.



7 - 11

Average employment (jobs per megawatt of solar photovoltaic system) over life of facility including manufacturing, construction, installation and operation & maintenance [ranges between 6.96 and 11.01 per MW](#)

Environmental Benefits

According to [RETScreen software](#), the GHG emission for **1 kWh** is **0.819 kgCO₂/kWh**. Referring to the energy produced by PV system which is around **1.44 GWh**, the gross annual GHG emission reduction CO₂ is **1098 tCO₂/yr** which would be equivalent to:



201 cars and light trucks not used per year

471,568 Liters of gasoline not consumed

977 Households reducing energy by 100%

378 Tonnes of waste recycled

101 Hectares of forest absorbing carbon

Additional Benefits

Source: RETScreen

Coverage of Energy Demand

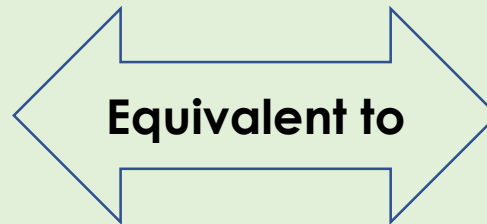
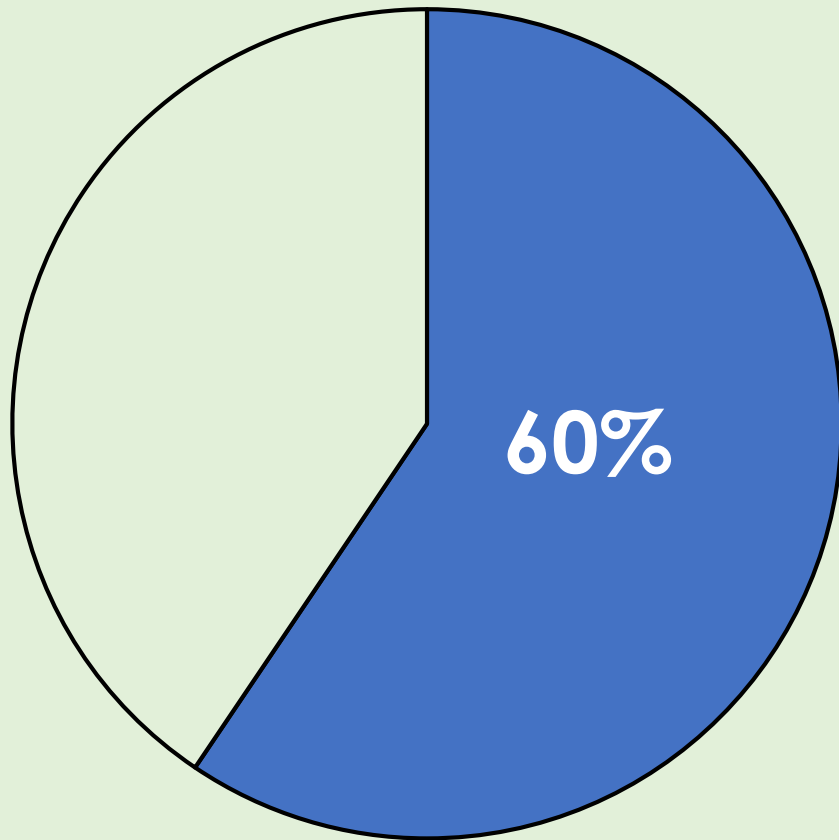

5607 Citizens

=

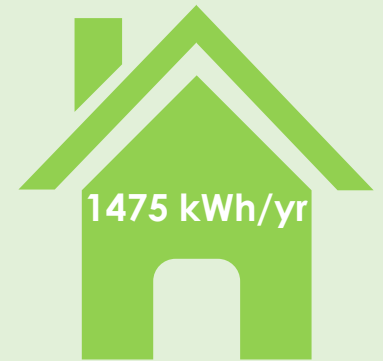

977 Households

The yearly average consumption of a religious building is **120** kWh/m²

6- Great Mosque of Algiers

Preliminary Solar Energy Assessment



This mosque is located in Mohammadia , Algeria. ($36^{\circ}44'05.9''\text{N}$ $3^{\circ}08'24.4''\text{E}$)

The optimal tilt angle of PV module is 30° and azimuth is south facing.

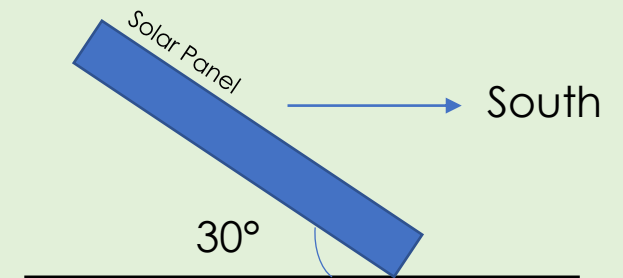

Source: Global Solar Atlas

Preliminary Solar Energy Assessment

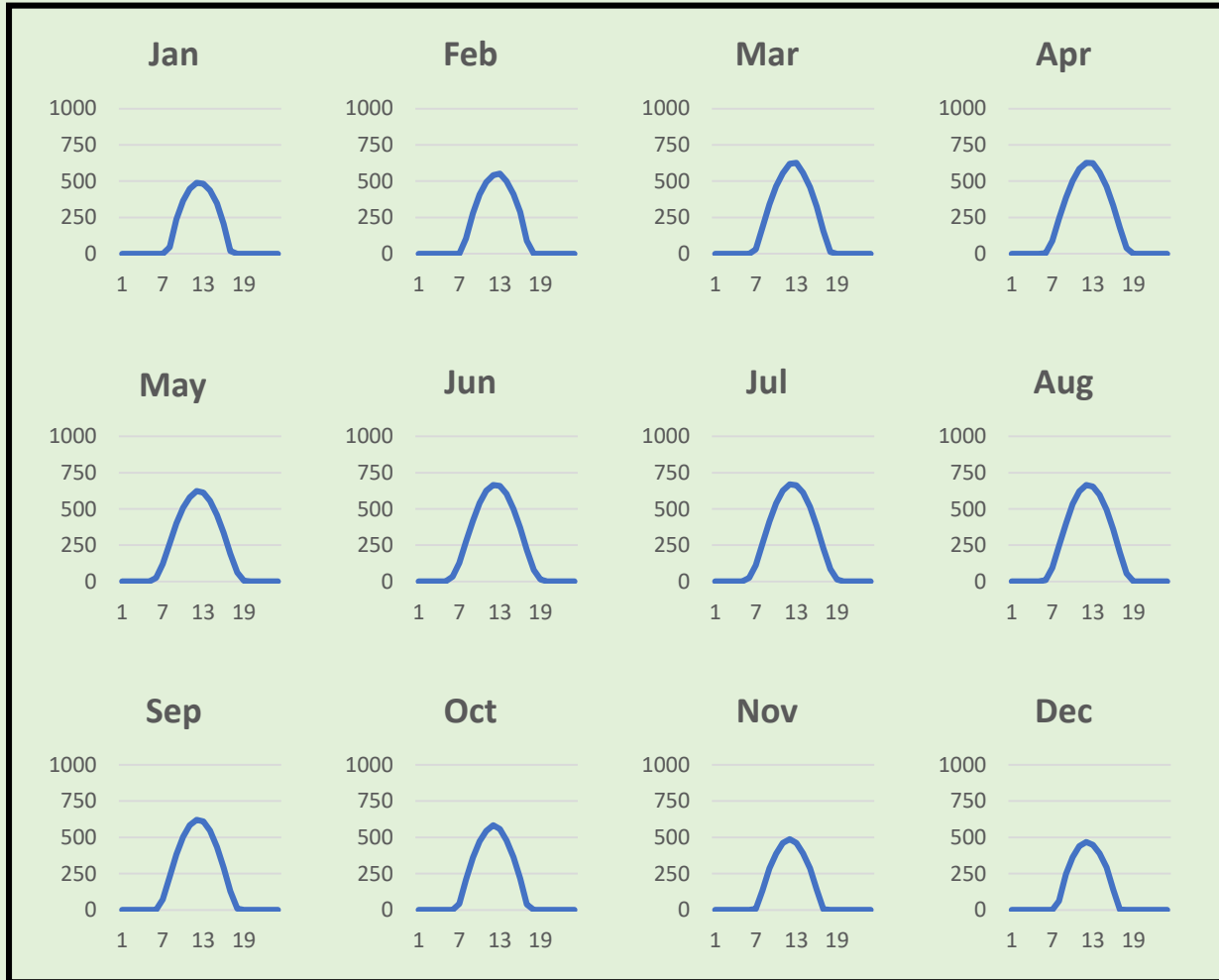

Average hourly profiles for each month
Total photovoltaic power output [Wh]

Total Photovoltaic Power Output per year
= 1515 kWh/kWp

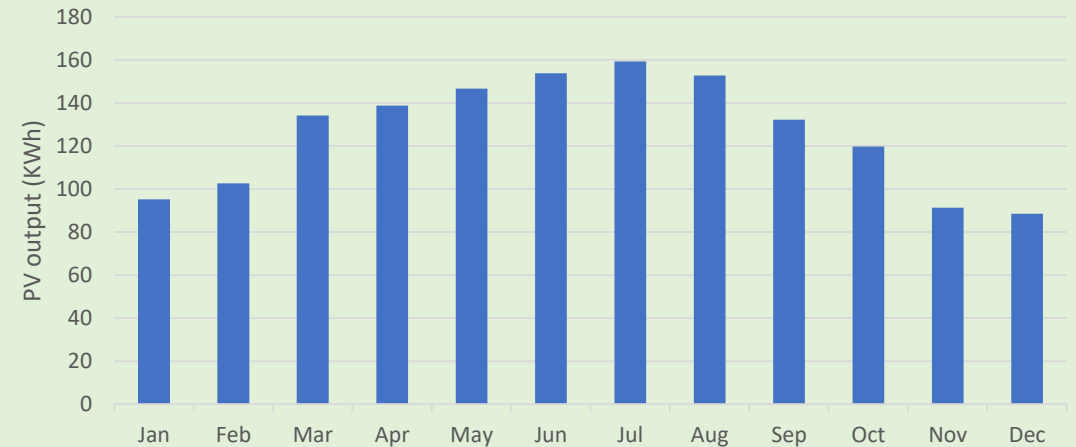

Monthly Averages

Total photovoltaic power output [kWh]

The figures show the hourly and monthly operation of 1 kWp PV system installed at Mohammadia town. We can conclude that the energy production ranges between 88 kWh/yr and 159 kWh/yr , with Moderate potential of solar energy.

Data source : Global Solar Atlas

Preliminary Solar Site Assessment

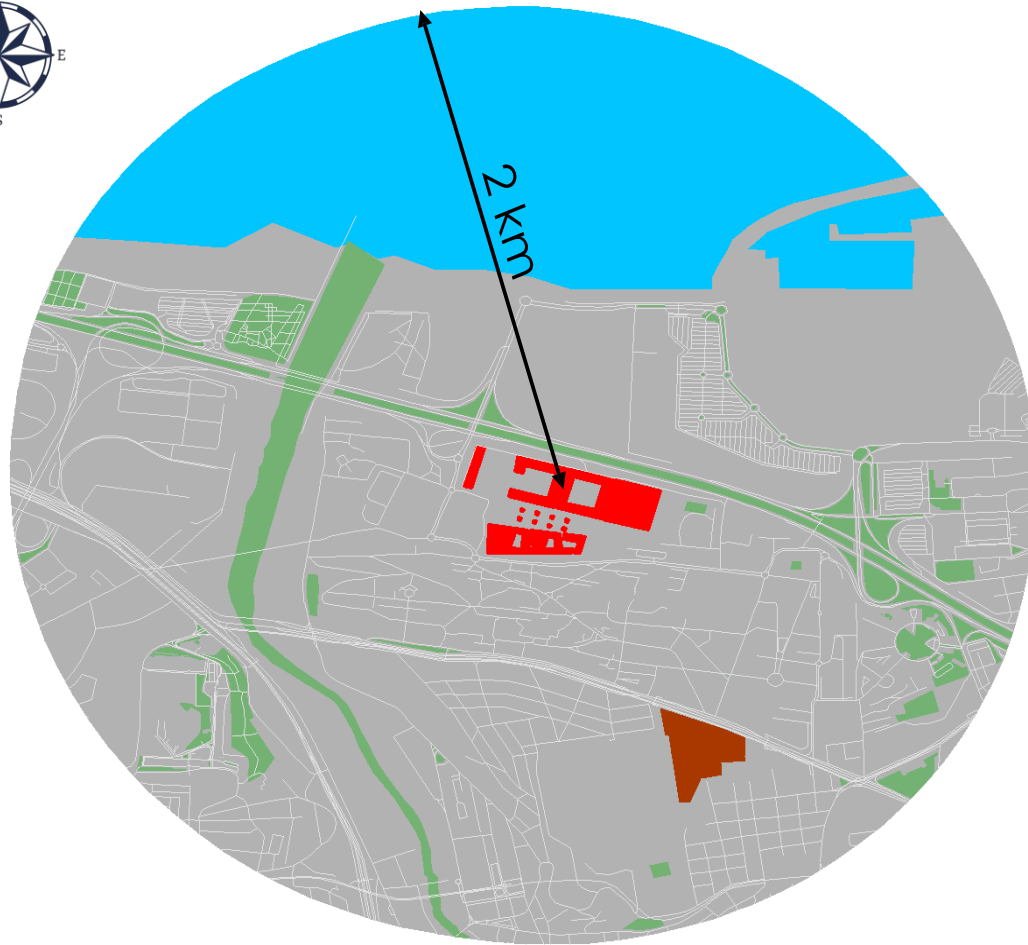

Land Use Type

- Roads
- Great Mosque
- Cemetery
- Green Area
- Bay of Algiers
- Urban Area

The adjacent map shows the land use type at radius 2 km from the mosque. Great mosque is located in a high dense urban coastal area with a few green areas.

Preliminary Solar Site Assessment

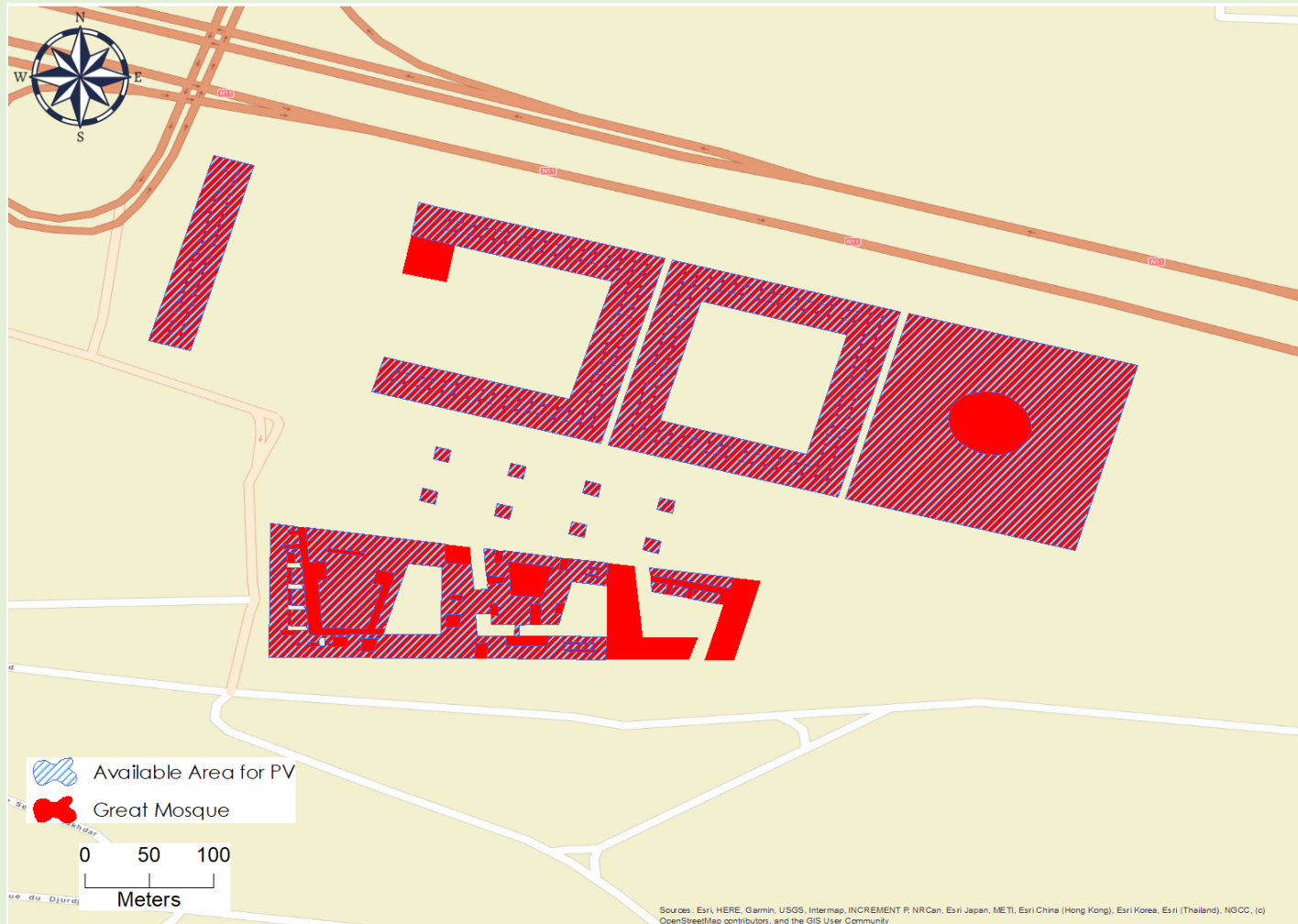

- The rooftop area of the mosque is: **71,850** m²
- Total area available for installing PV system is : **60,440** m²

PV Design of Mosque's Rooftop

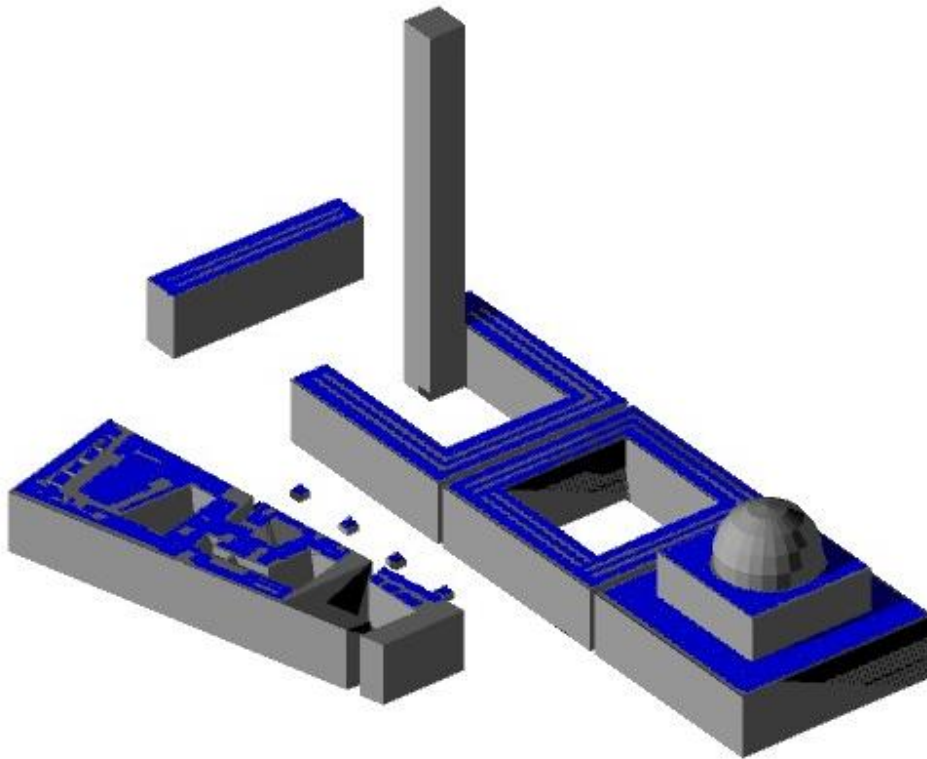

	Solar System Parameters
PV Module	Model: LR5-72 HPH 550 M
Manufacturer	Longi Solar
Nominal PV Power (kWp)	3925
Total Number of modules	7136 (16 in series , 446 in Parallel)
Total Area of Modules (m ²)	18240
Total Number of Sheds	7138
Inverter	Model: PVS800-57-0875Kw-B
Manufacturer	ABB
Nominal Inverter Power (kWac)	3500 (4 inverters each 875)
System Production	
Total Produced Energy (MWh/year)	5612
System Performance Ratio (%)	76
System Cost	\$3,925,000

Economic Benefits

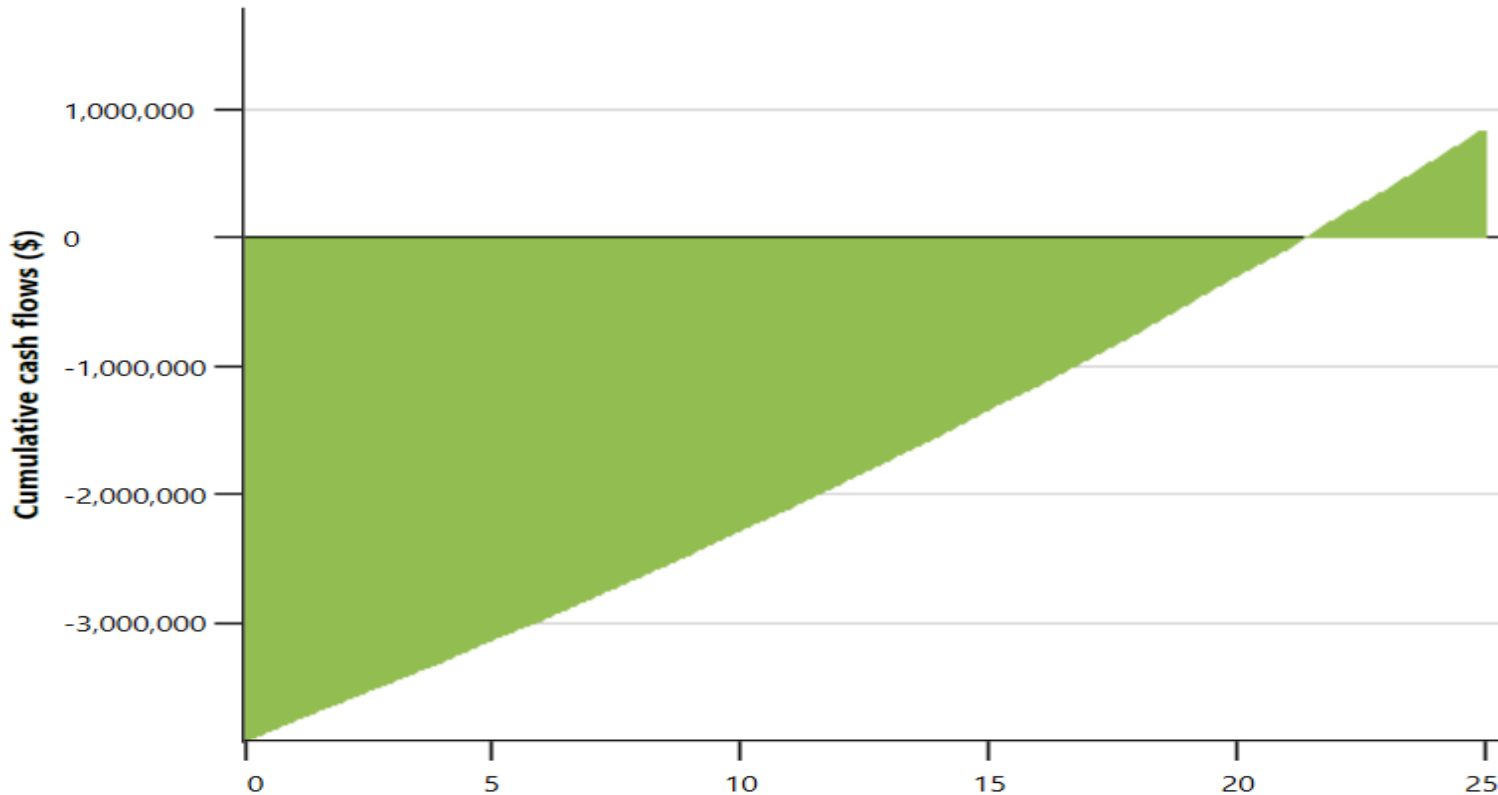

- Total Initial Cost = **\$3,925,000**
(Considering 1000 \$ /KWp - Ref: RETScreen)
- O&M Cost = **\$39,250/yr**
(Considering 10 \$ /KWp/yr - Ref: RETScreen)
- Savings = **\$145,750/yr**
(0.033\$/kWh in Algeria- Ref: Global Petrol Prices)
- IRR = **1.4%**
- Simple payback = **26.9 yr**
- Benefit-Cost Ratio = **0.44**

Potential Jobs Created

Source: UNEP/ILO/IOE/ITUC, 2008.



27 - 43

Average employment (jobs per megawatt of solar photovoltaic system) over life of facility including manufacturing, construction, installation and operation & maintenance [ranges between 6.96 and 11.01 per MW](#)

Environmental Benefits

According to [RETScreen software](#), the GHG emission for 1 kWh is **0.542** kgCO₂/kWh. Referring to the energy produced by PV system which is around **5.6** GWh, the gross annual GHG emission reduction CO₂ is **2829** tCO₂/yr which would be equivalent to:



518 cars and light trucks not used per year

1,215,378 Liters of gasoline not consumed

2818 Households reducing energy by 100%

975 Tonnes of waste recycled

260 Hectares of forest absorbing carbon

Additional Benefits

Source: RETScreen

Coverage of Energy Demand

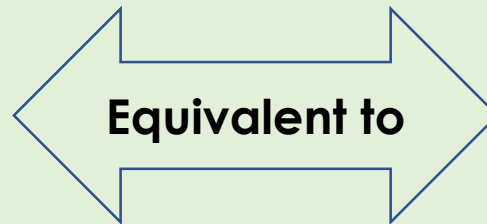
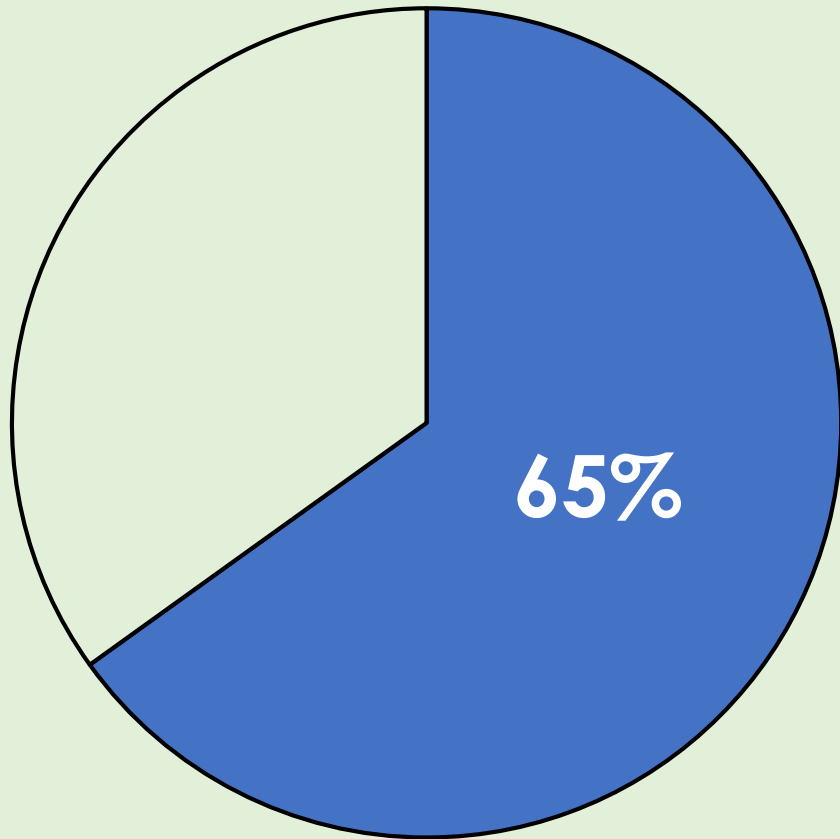

17375 Citizens

=

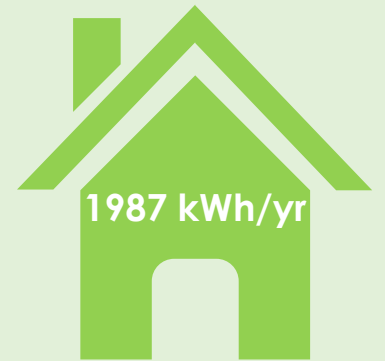

2824 Households

The yearly average consumption of religious building is **120** kWh/m²

7- Nizamiyeh Mosque

Preliminary Solar Energy Assessment

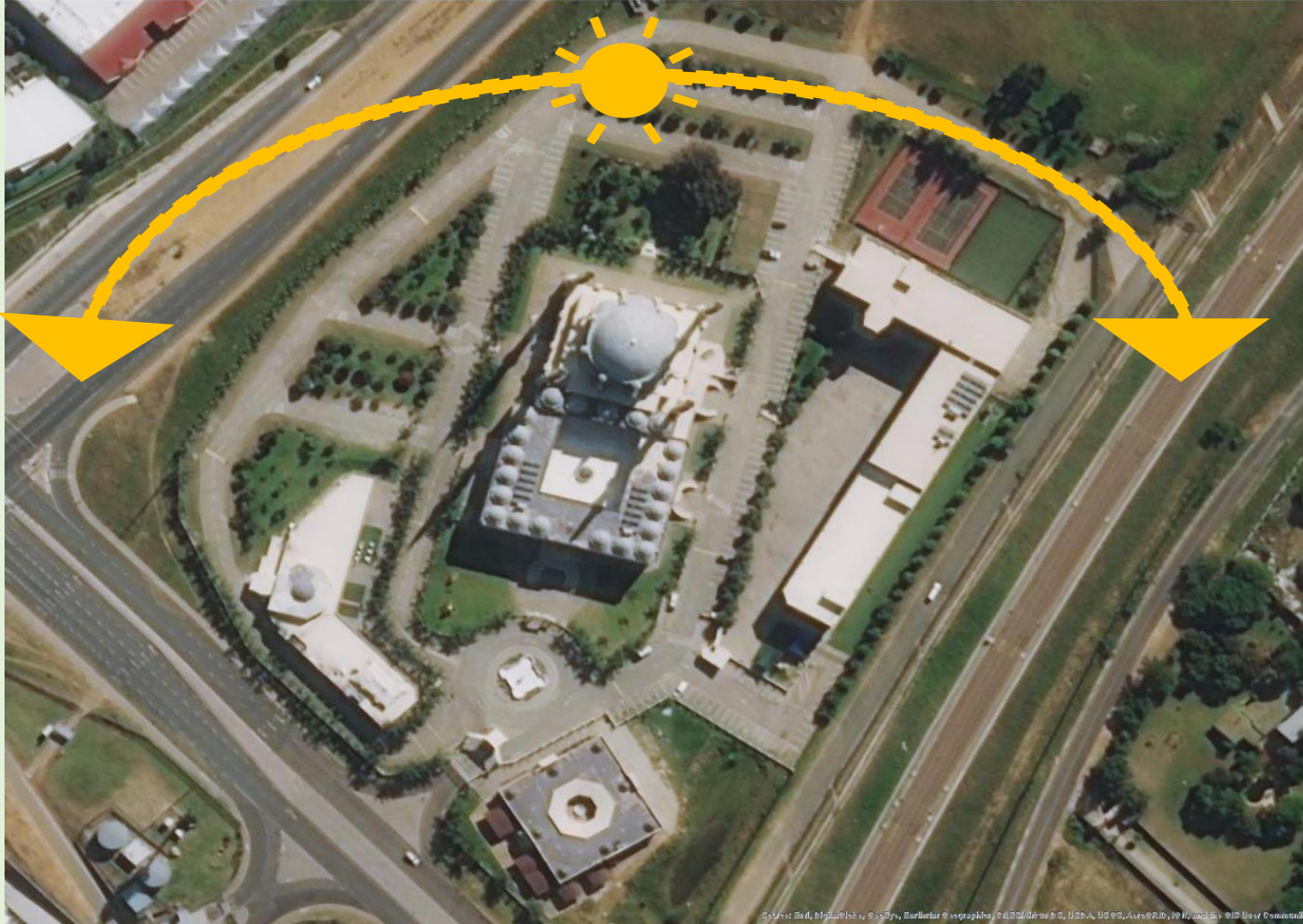

This mosque is located in Midrand, South Africa. ($26^{\circ}00'50.4''S$ $28^{\circ}07'46.9''E$)

The optimal tilt angle of PV module is 29° and azimuth is north facing.

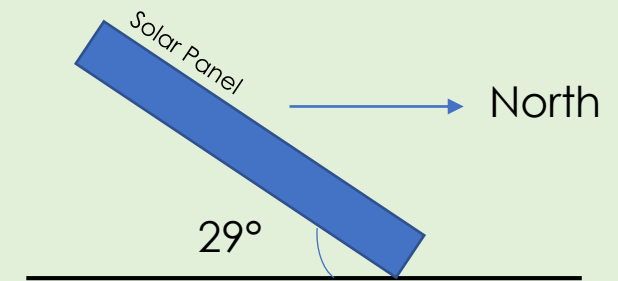

Source: Global Solar Atlas

Preliminary Solar Energy Assessment

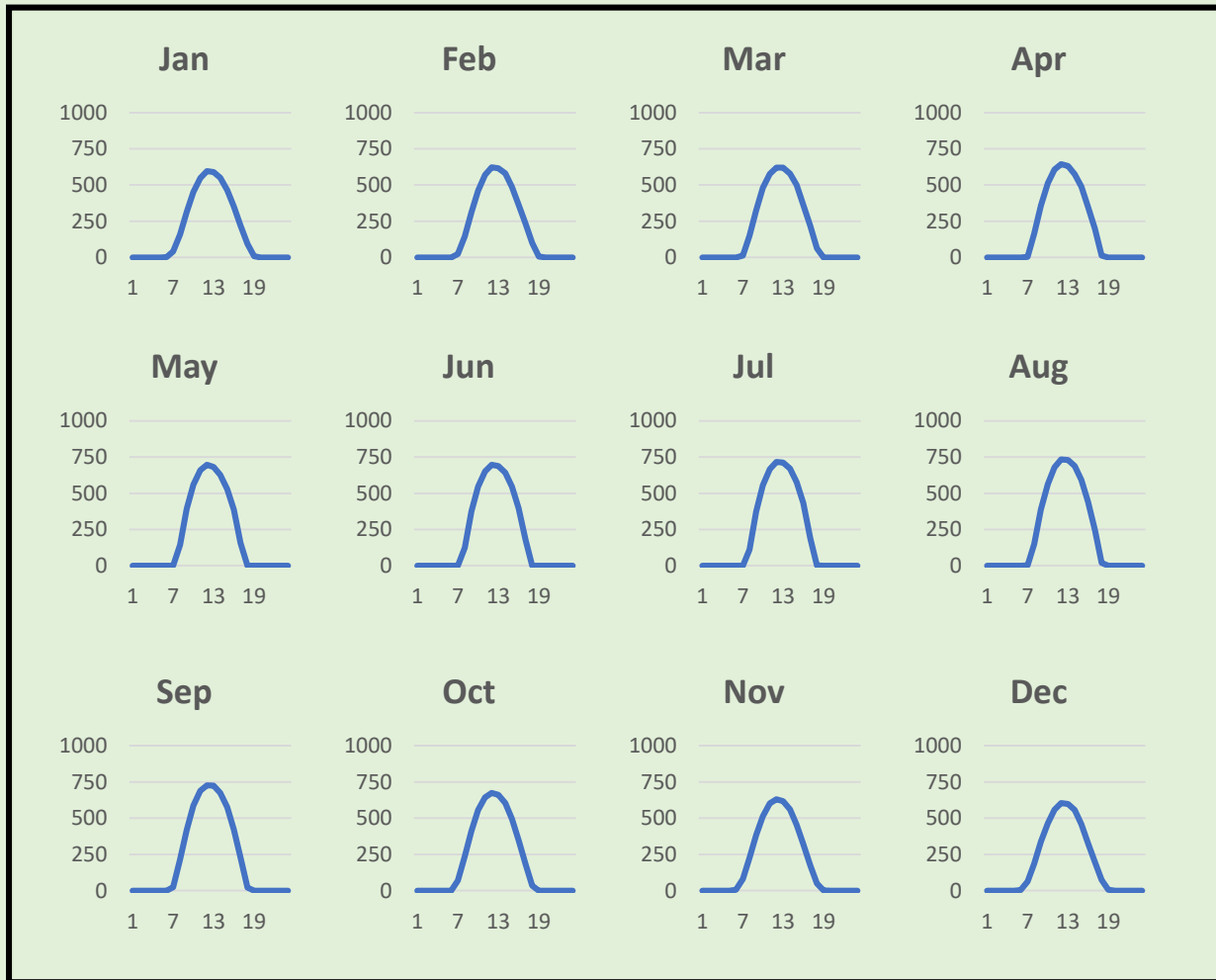

Average hourly profiles for each month
Total photovoltaic power output [Wh]

Total Photovoltaic Power Output per year
= 1738 kWh/kWp

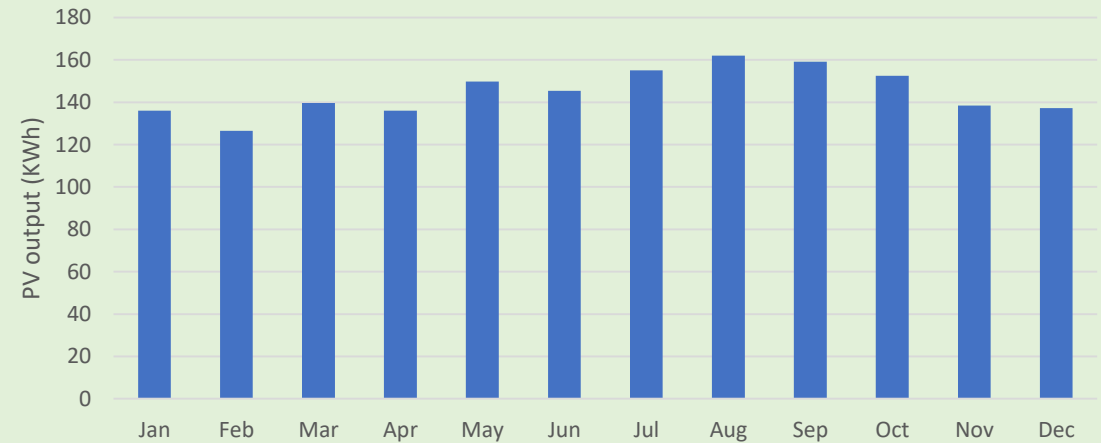

Monthly Averages

Total photovoltaic power output [kWh]

The figures show the hourly and monthly operation of 1 kWp PV system installed in Midrand. We can conclude that the energy production ranges between 126 kWh/yr and 162 kWh/yr , with High potential of solar energy.
Data source : Global Solar Atlas

Preliminary Solar Site Assessment

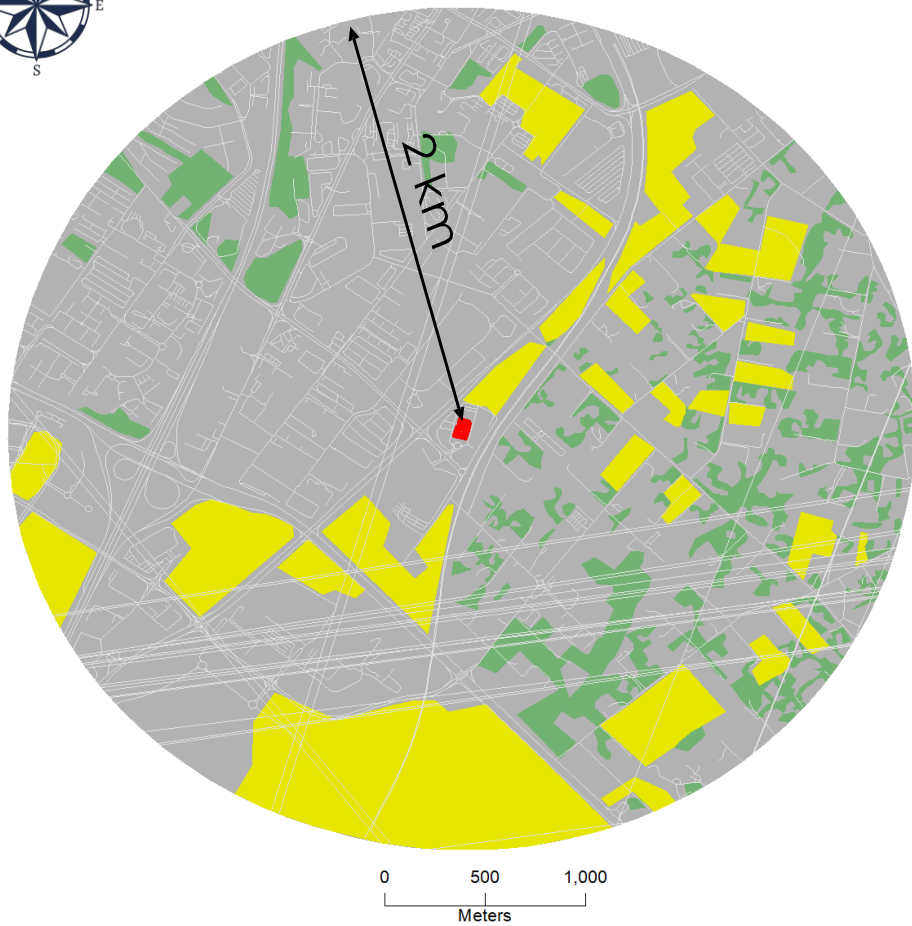

Land Use Type

- Roads
- Green Area
- Natural Land
- Nizamiye Mosque
- Urban Area

The adjacent map shows the land use type at radius 2 km from the mosque. Nizamiye mosque is located in a high density urban area with a large green areas and natural lands.

Preliminary Solar Site Assessment



- The rooftop area of the mosque is: **3,330** m²
- Total area available for installing PV system is : **1,110** m²

PV Design of Mosque's Rooftop

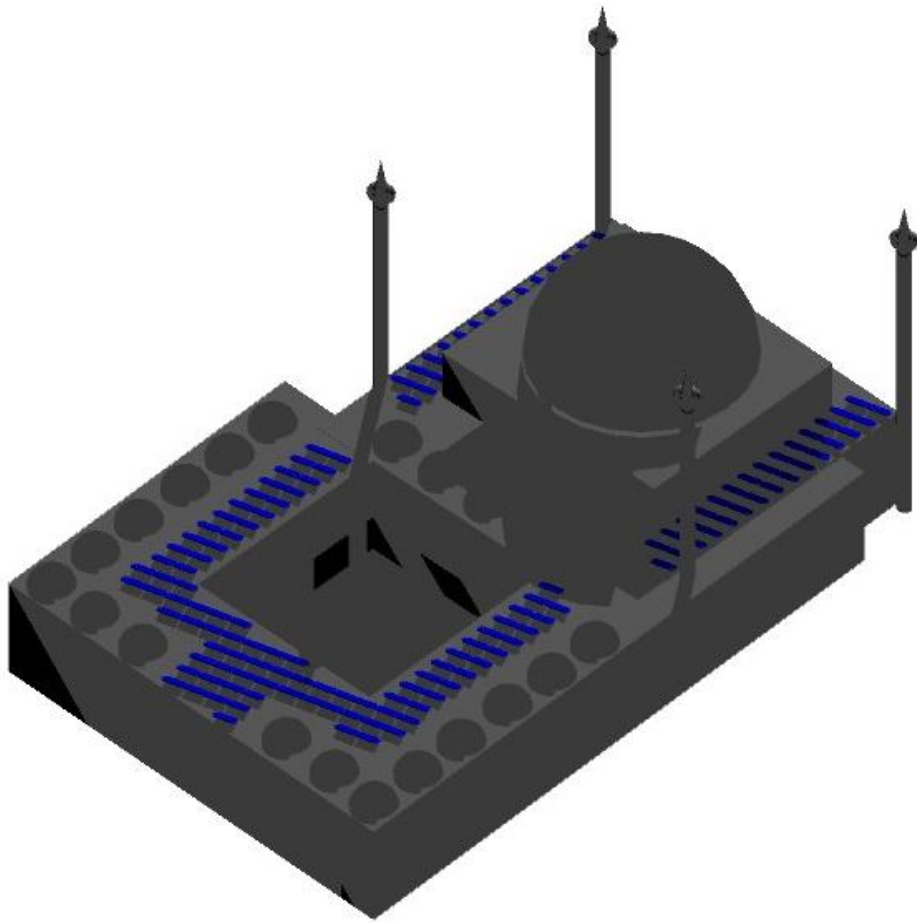

	Solar System Parameters
PV Module	Model: LR5-72 HPH 550 M
Manufacturer	Longi Solar
Nominal PV Power (kWp)	78.7
Total Number of modules	143 (13 in series , 11 in Parallel)
Total Area of Modules (m ²)	366
Total Number of Sheds	148
Inverter	Model: PVM2-45-075-TT
Manufacturer	LTi REEnergy
Nominal Inverter Power (kWac)	75
System Production	
Total Produced Energy (MWh/year)	144
System Performance Ratio (%)	74
System Cost	\$78,700

Economic Benefits

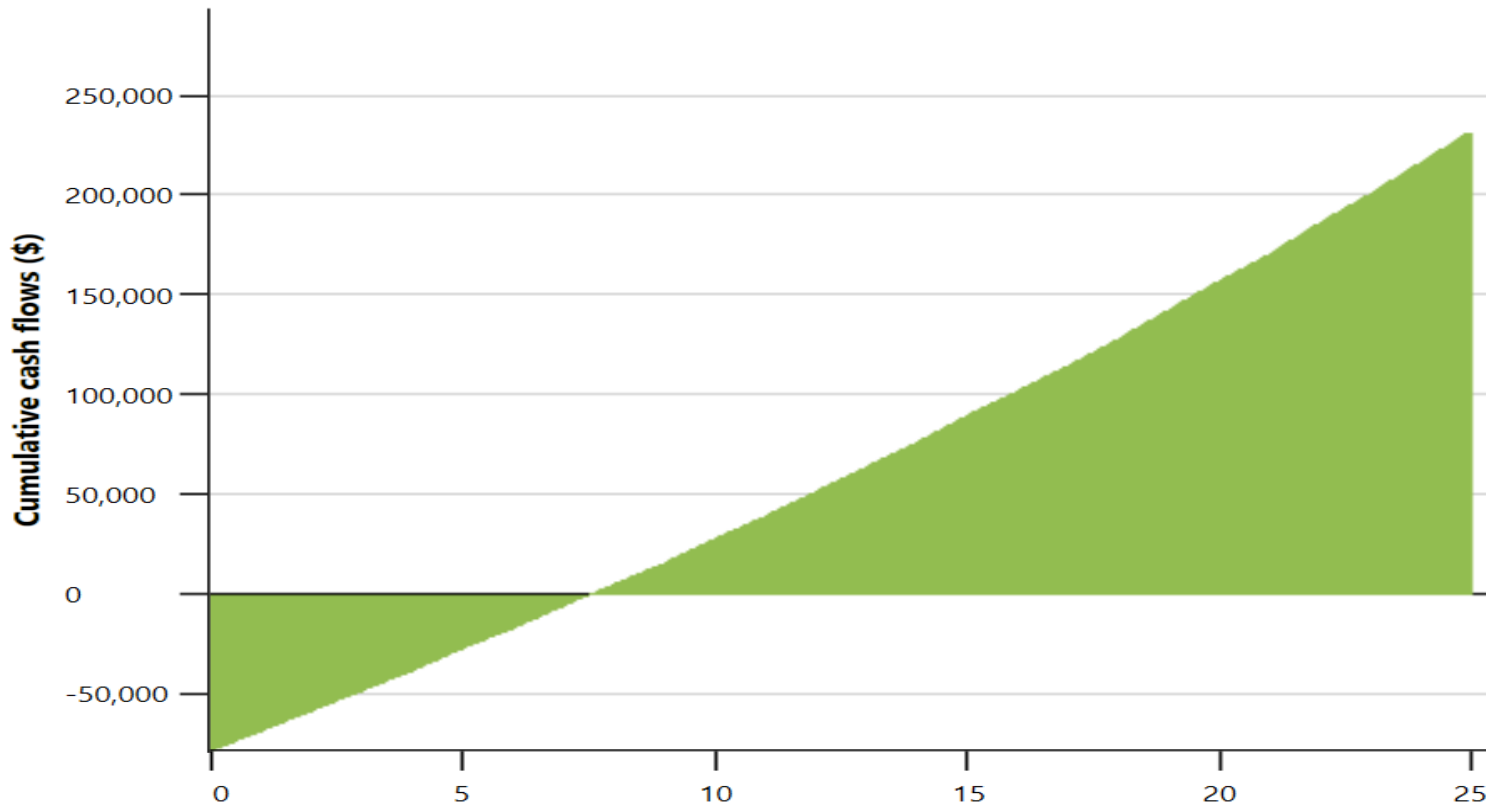

- Total Initial Cost = **\$78,700**
(Considering 1000 \$ /KWp - Ref: RETScreen)
- O&M Cost = **\$787/yr**
(Considering 10 \$ /KWp/yr - Ref: RETScreen)
- Savings = **\$9,493/yr**
(0.071\$/kWh in South Africa– Ref: Global Petrol Prices)
- NPV = **\$33,300**
- IRR = **13.4%**
- Simple payback = **8.3 yr**
- Benefit-Cost Ratio = **1.4**

Potential Jobs Created

Source: UNEP/ILO/IOE/ITUC, 2008.



1

Average employment (jobs per megawatt of solar photovoltaic system) over life of facility including manufacturing, construction, installation and operation & maintenance [ranges between 6.96 and 11.01 per MW](#)

Environmental Benefits

According to [RETScreen software](#), the GHG emission for 1 kWh is **0.958** kgCO₂/kWh. Referring to the energy produced by PV system which is around **0.144** GWh, the gross annual GHG emission reduction CO₂ is **128** tCO₂/yr which would be equivalent to:



24 and light trucks
not used per year

55,181 Liters of
gasoline not
consumed

51 Households
reducing energy
by 100%

44 Tonnes of
waste recycled

12 Hectares of
forest absorbing
carbon

Additional Benefits

Source: RETScreen

Coverage of Energy Demand

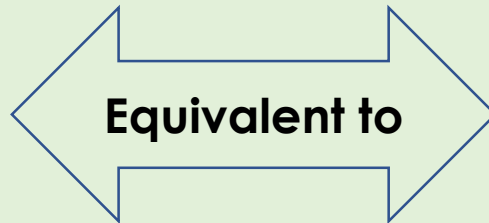
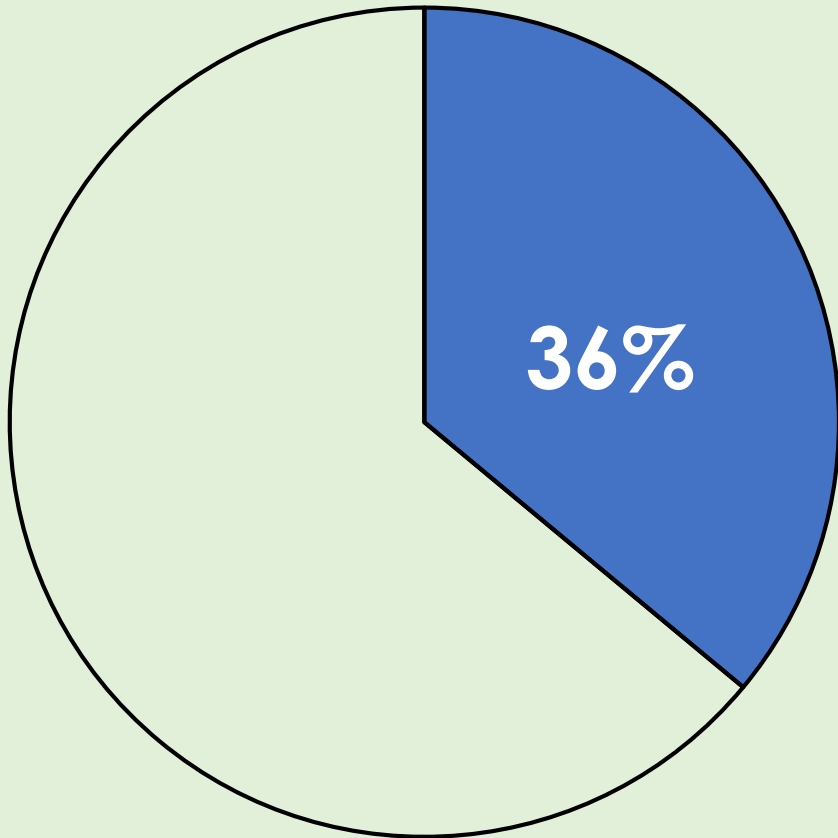

878 Citizens

=

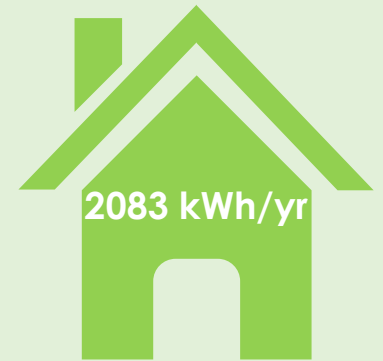

51 Households

The yearly average consumption of a religious building is **120** kWh/m²

8- Al Haram Mosque

Preliminary Solar Energy Assessment



This mosque is located in Mecca, Saudi Arabia. ($21^{\circ}25'17.9''\text{N}$ $39^{\circ}49'34.2''\text{E}$)

The optimal tilt angle of PV module is 22° and azimuth is south facing.

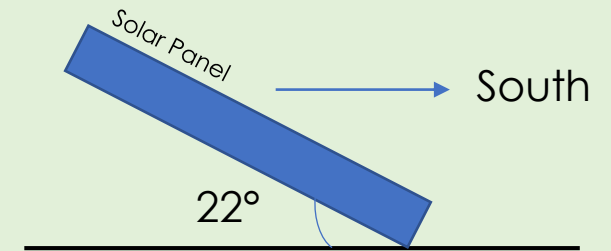

Source: Global Solar Atlas

Preliminary Solar Energy Assessment

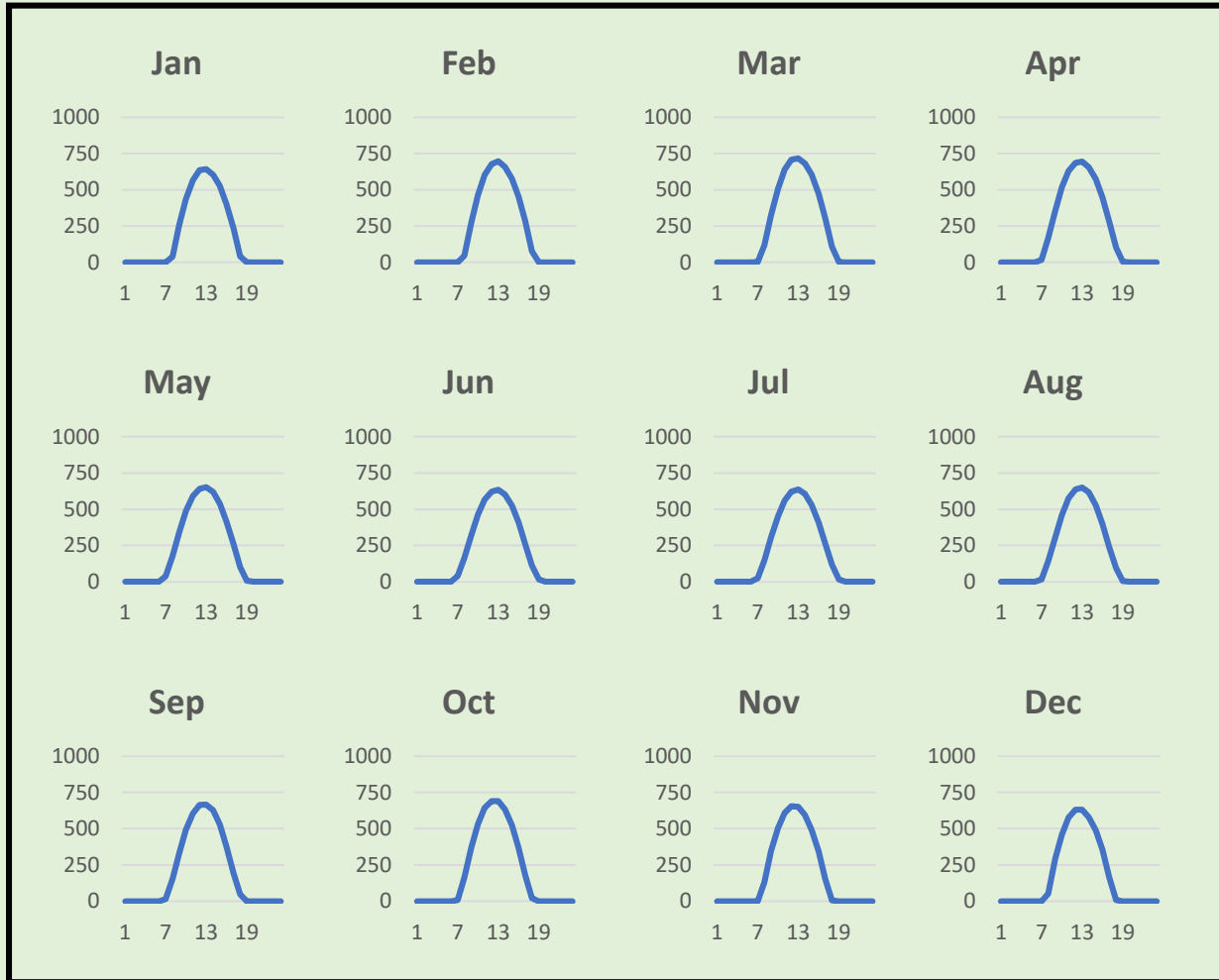

Average hourly profiles for each month
Total photovoltaic power output [Wh]

Total Photovoltaic Power Output per year
= 1726 kWh/kWp

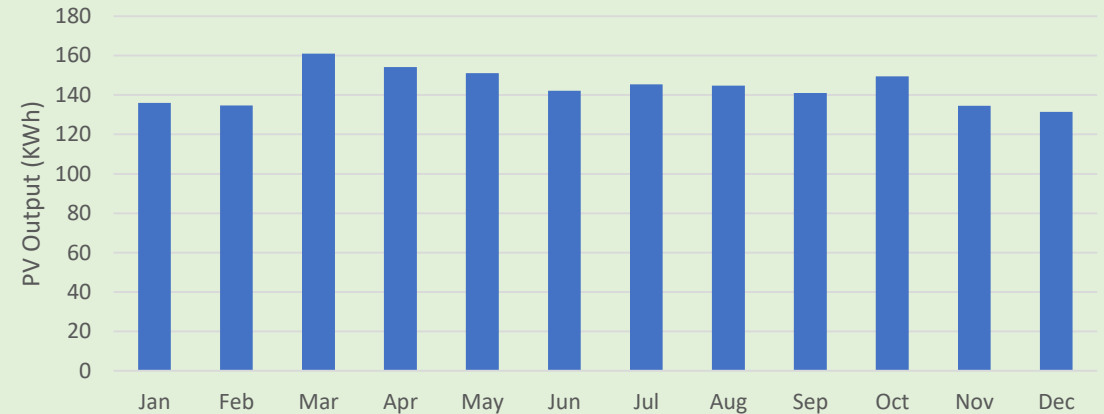

Monthly Averages

Total photovoltaic power output [kWh]

The figures show the hourly and monthly operation of 1 kWp PV system installed at Mecca. We can conclude that the energy production ranges between 131 kWh/yr and 161 kWh/yr , with high potential of solar energy.
Data source : Global Solar Atlas

Preliminary Solar Site Assessment

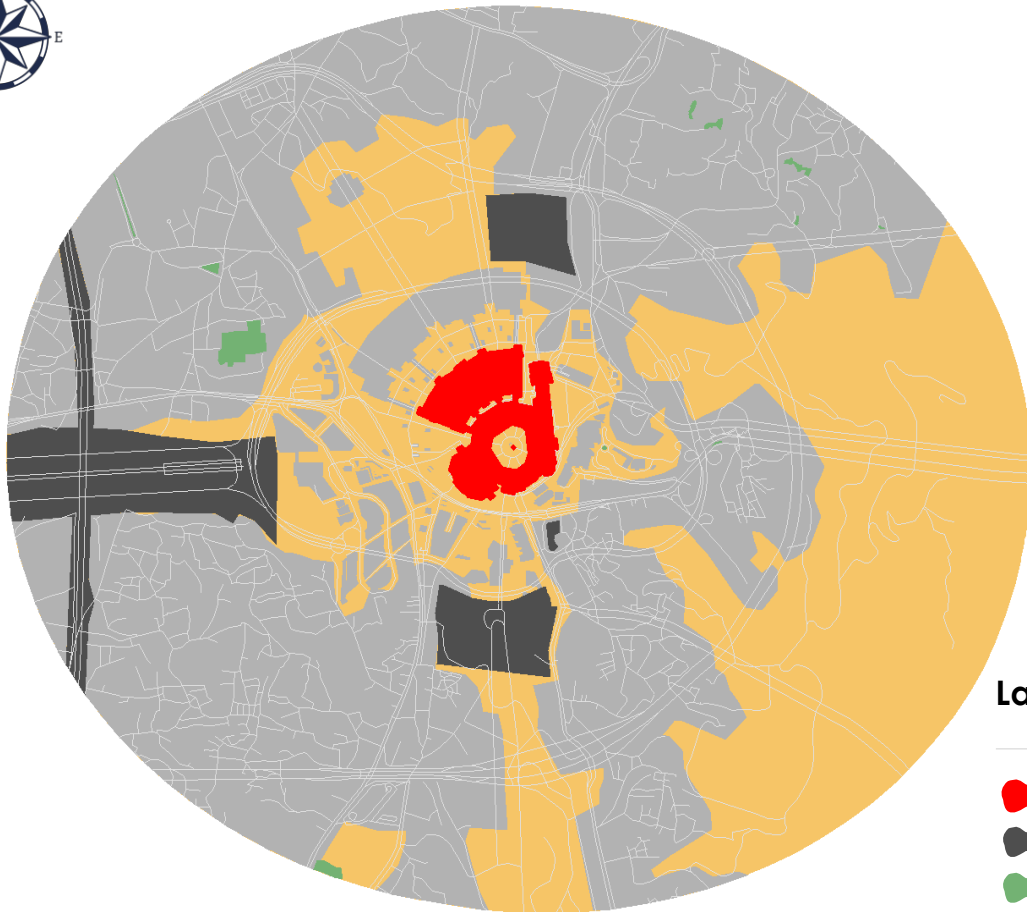

Land Use Type

- Roads
- AL Haram Mosque
- Construction Area
- Green Area
- Urban Area
- Mountain & Empty Area

The adjacent map shows the land use type at radius 2 km from the mosque. Al Haram mosque is located in a high density urban area with a few green areas and surrounded by mountains.

Preliminary Solar Site Assessment

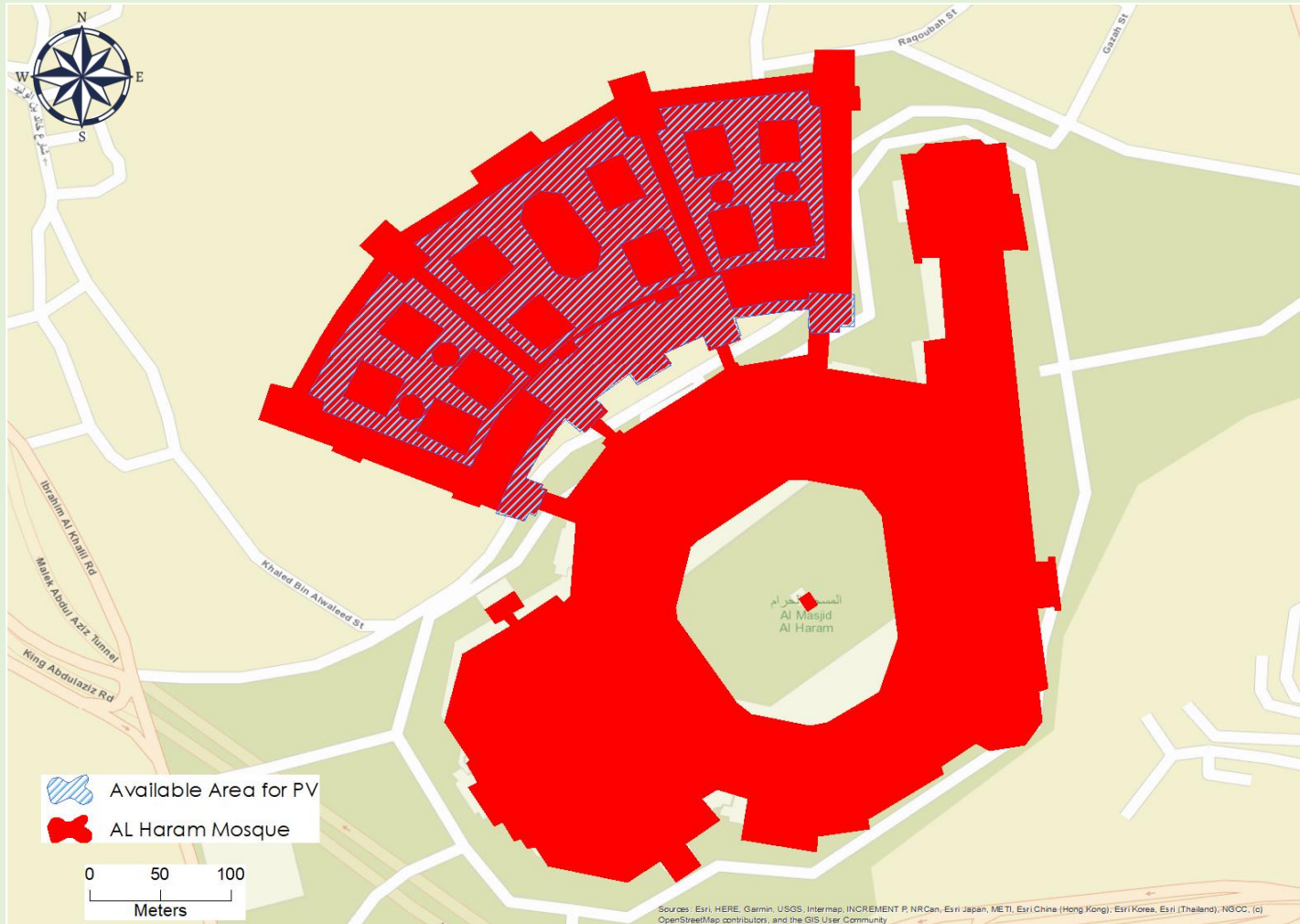

- The rooftop area of the mosque is : **164,000** m²
- Total Area available for installing PV system is : **32,260** m²

PV Design of Mosque's Rooftop

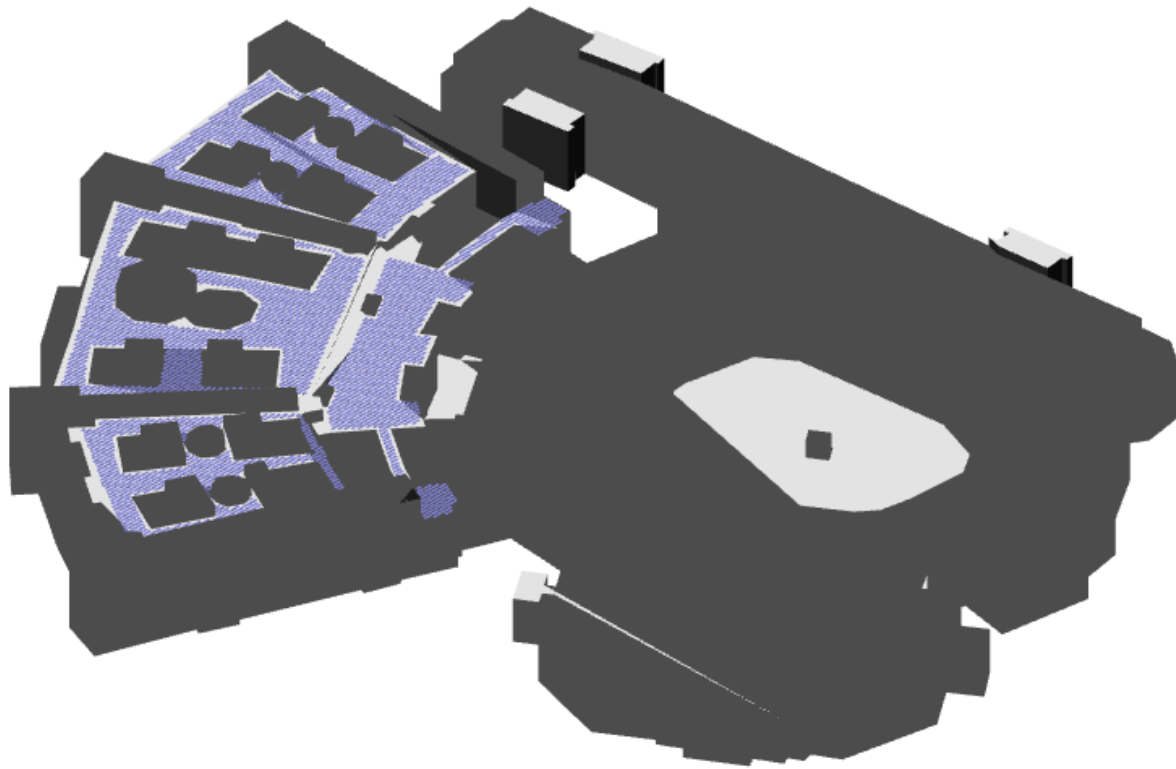

	Solar System Parameters
PV Module	Model: LR5-72 HPH 540 M
Manufacturer	Longi Solar
Nominal PV Power (kWp)	2634
Total Number of modules	4878 (18 in series , 271 in Parallel)
Total Area of Modules (m ²)	12468
Total Number of Sheds	4878
Inverter	Model: FreeSun FS1130 HES 330V
Manufacturer	Power Electronics
Nominal Inverter Power (kWac)	2260 (2 inverters each 1130)
System Production	
Total Produced Energy (MWh/year)	4564
System Performance Ratio (%)	73
System Cost	\$2,634,000

Economic Benefits

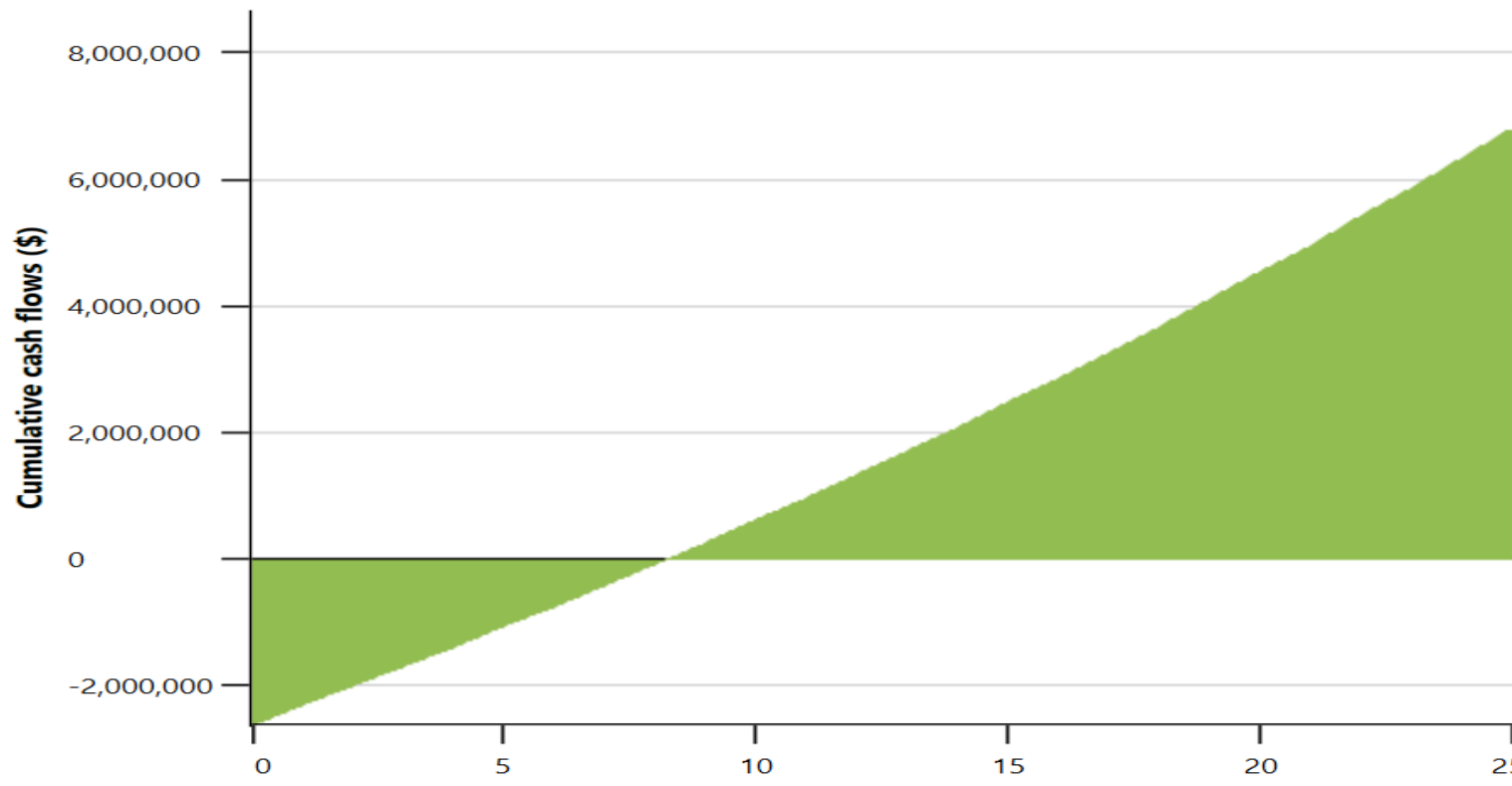

- Total Initial Cost = **\$2,634,000**
(Considering 1000 \$ /KWp - Ref: RETScreen)
- O&M Cost = **\$26,340/yr**
(Considering 10 \$ /KWp/yr - Ref: RETScreen)
- Savings = **\$288,420/yr**
(0.069\$/kWh in Saudi Arabia – Ref: Global Petrol Prices)
- NPV = **\$769,000**
- IRR = **12.1%**
- Simple payback = **9.1 yr**
- Benefit-Cost Ratio = **1.3**

Potential Jobs Created

Source: UNEP/ILO/IOE/ITUC, 2008.



18 - 29

Average employment (jobs per megawatt of solar photovoltaic system) over life of facility including manufacturing, construction, installation and operation & maintenance [ranges between 6.96 and 11.01 per MW](#)

Environmental Benefits

According to **RETScreen software**, the GHG emission for **1 kWh** is **0.556 kgCO₂/kWh**. Referring to the energy produced by PV system which is around **4.564 GWh**, the gross annual GHG emission reduction CO₂ is **2359 tCO₂/yr** which would be equivalent to:



432 cars and light trucks not used per year

1,013,458 Liters of gasoline not consumed

1058 Citizens reducing energy by 100%

813 Tonnes of waste recycled

217 Hectares of forest absorbing carbon

Additional Benefits

Source: RETScreen

Coverage of Energy Demand

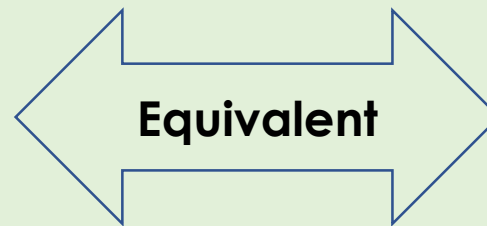
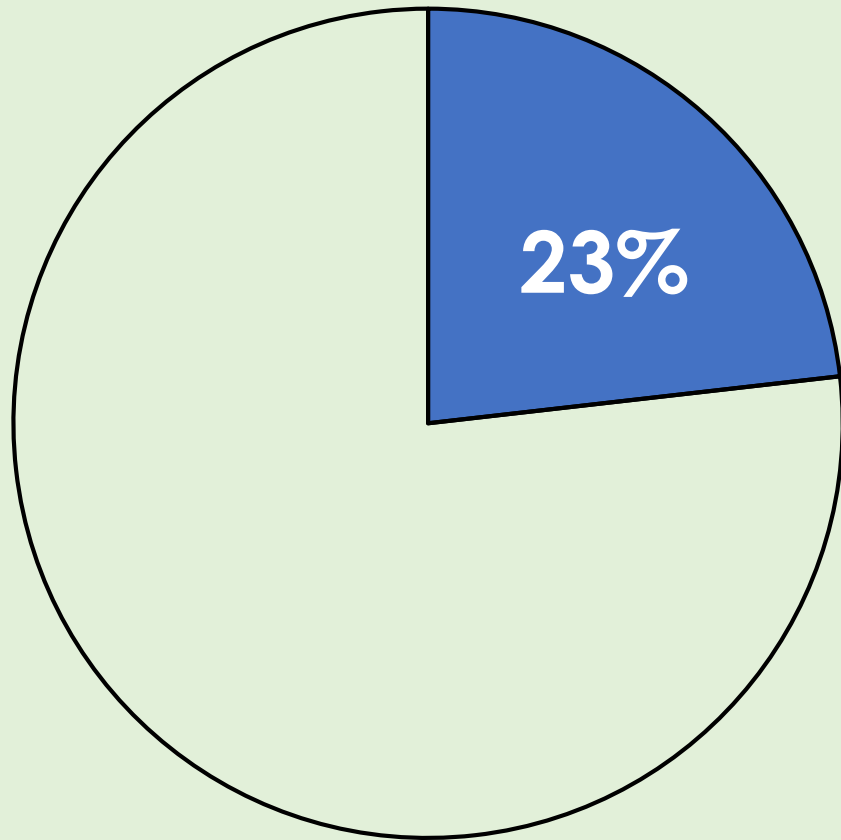

1058 Citizens

The yearly average consumption of a religious building is **120** kWh/m²

9- Ummayed Mosque

Preliminary Solar Energy Assessment

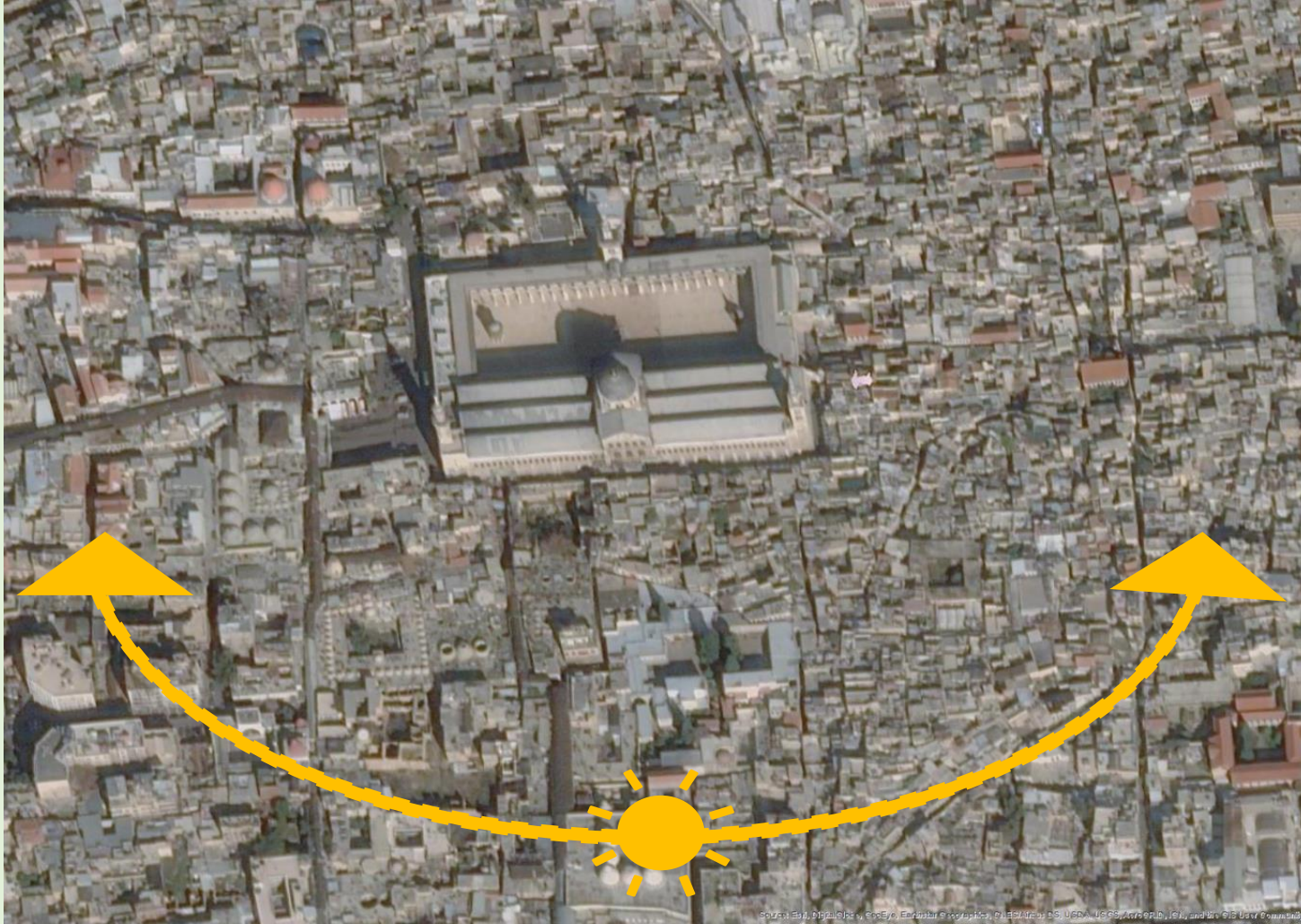

This mosque is located in Damascus, Syria. ($33^{\circ}30'40.6''\text{N}$ $36^{\circ}18'25.9''\text{E}$)

The optimal tilt angle of PV module is 29° and azimuth is south facing.

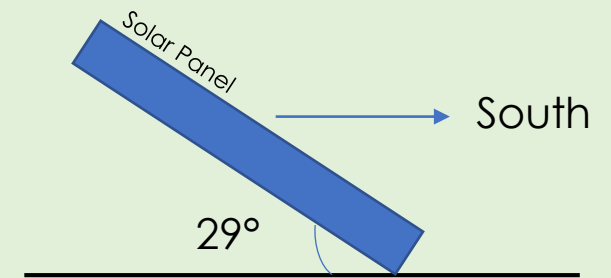

Source: Global Solar Atlas

Preliminary Solar Energy Assessment

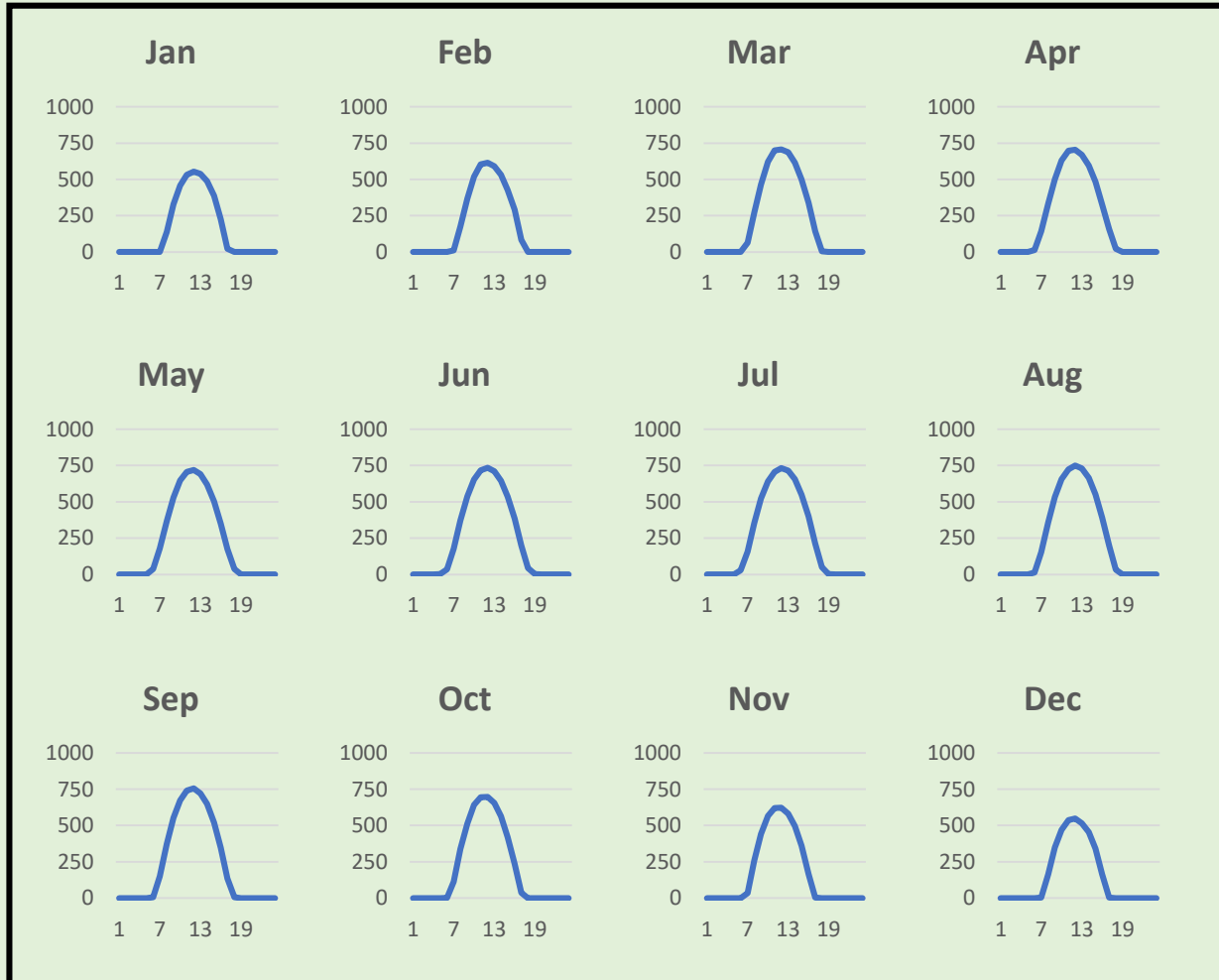

Average hourly profiles for each month
Total photovoltaic power output [Wh]

Total Photovoltaic Power Output per year
= 1805 kWh/kWp

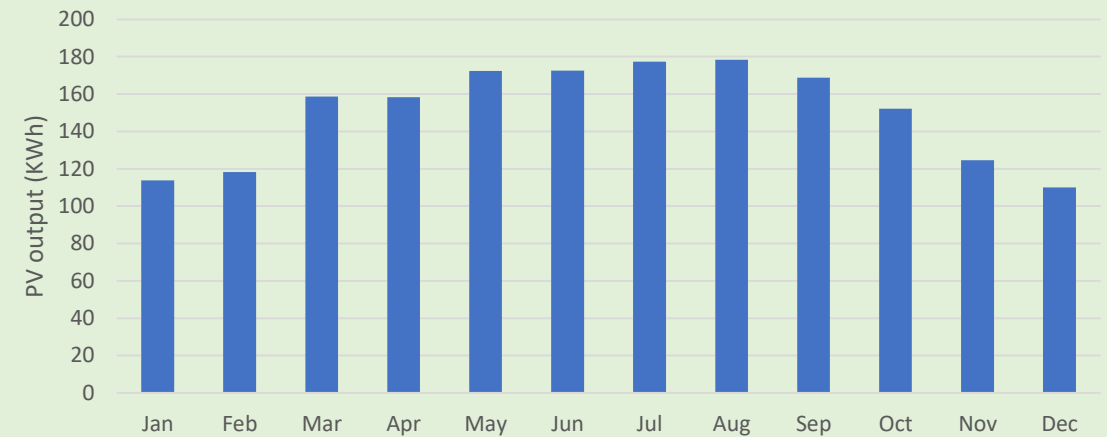

Monthly Averages



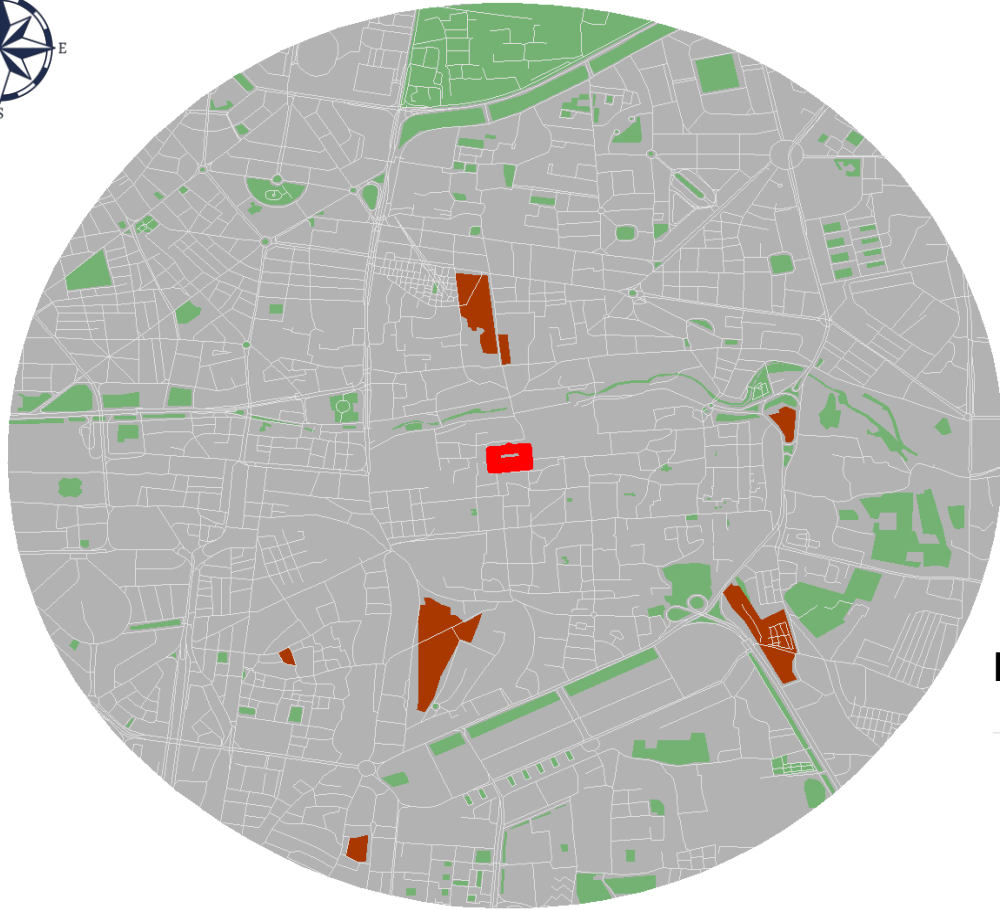

Total photovoltaic power output [kWh]

The figures show the hourly and monthly operation of 1 kWp PV system installed in Damascus. We can conclude that the energy production ranges between 110 kWh/yr and 178 kWh/yr, with High potential of solar energy.
Data source : Global Solar Atlas

Preliminary Solar Site Assessment



Land Use Type

- Roads
-  Umayyad Mosque
-  Cemetery
-  Green Area
-  Urban Area

The adjacent map shows the land use type at radius 2 km from the mosque. Umayyad mosque is located in a high dense urban area with a few green areas.

Preliminary Solar Site Assessment

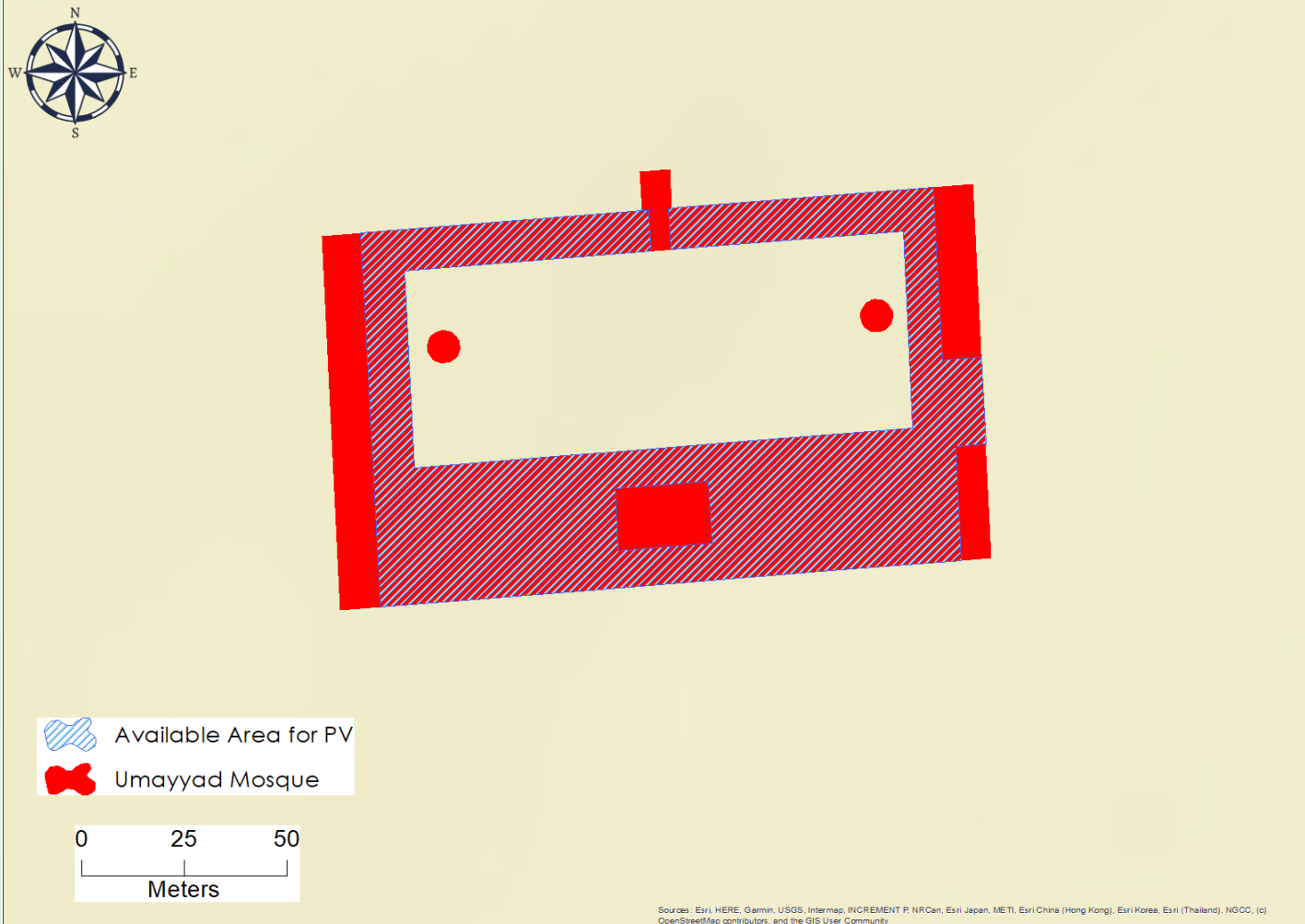

- The rooftop area of the mosque is: **8,790** m²
- Total area available for installing PV system is : **6,730** m²

PV Design of Mosque's Rooftop

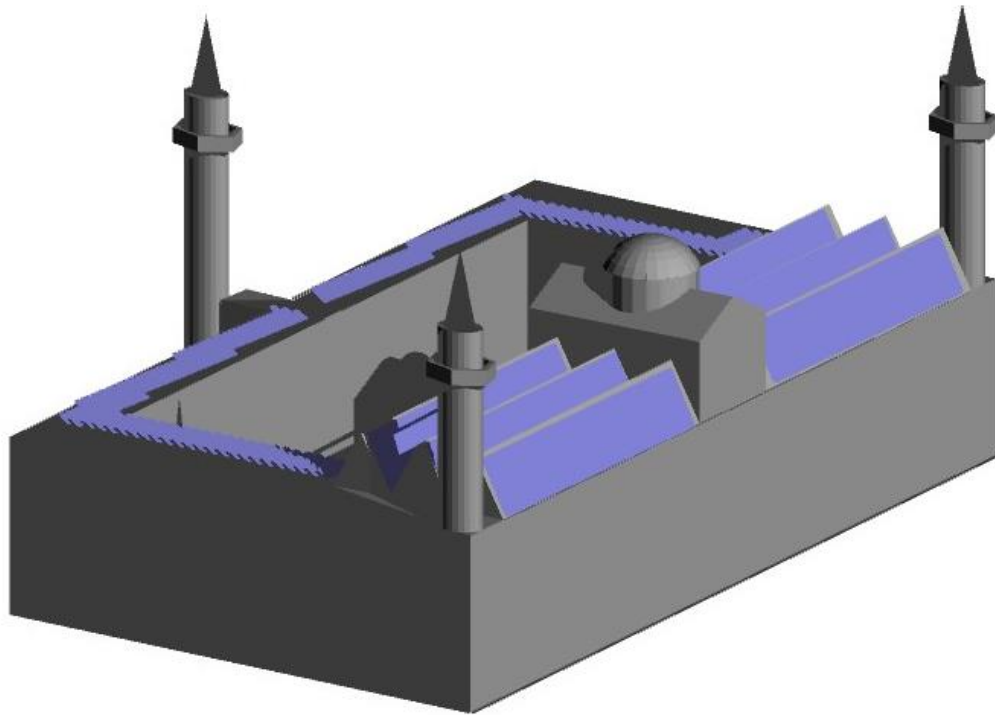

	Solar System Parameters
PV Module	Model: LR5-72 HPH 550 M
Manufacturer	Longi Solar
Nominal PV Power (kWp)	960
Total Number of modules	1746 (18 in series , 97 in Parallel)
Total Area of Modules (m ²)	4463
Total Number of Sheds	1749
Inverter	Model: RPS 1040 Master-Slave
Manufacturer	Bonfiglioli Vectron
Nominal Inverter Power (kWac)	917
System Production	
Total Produced Energy (MWh/year)	1532
System Performance Ratio (%)	71
System Cost	\$960,000

Economic Benefits

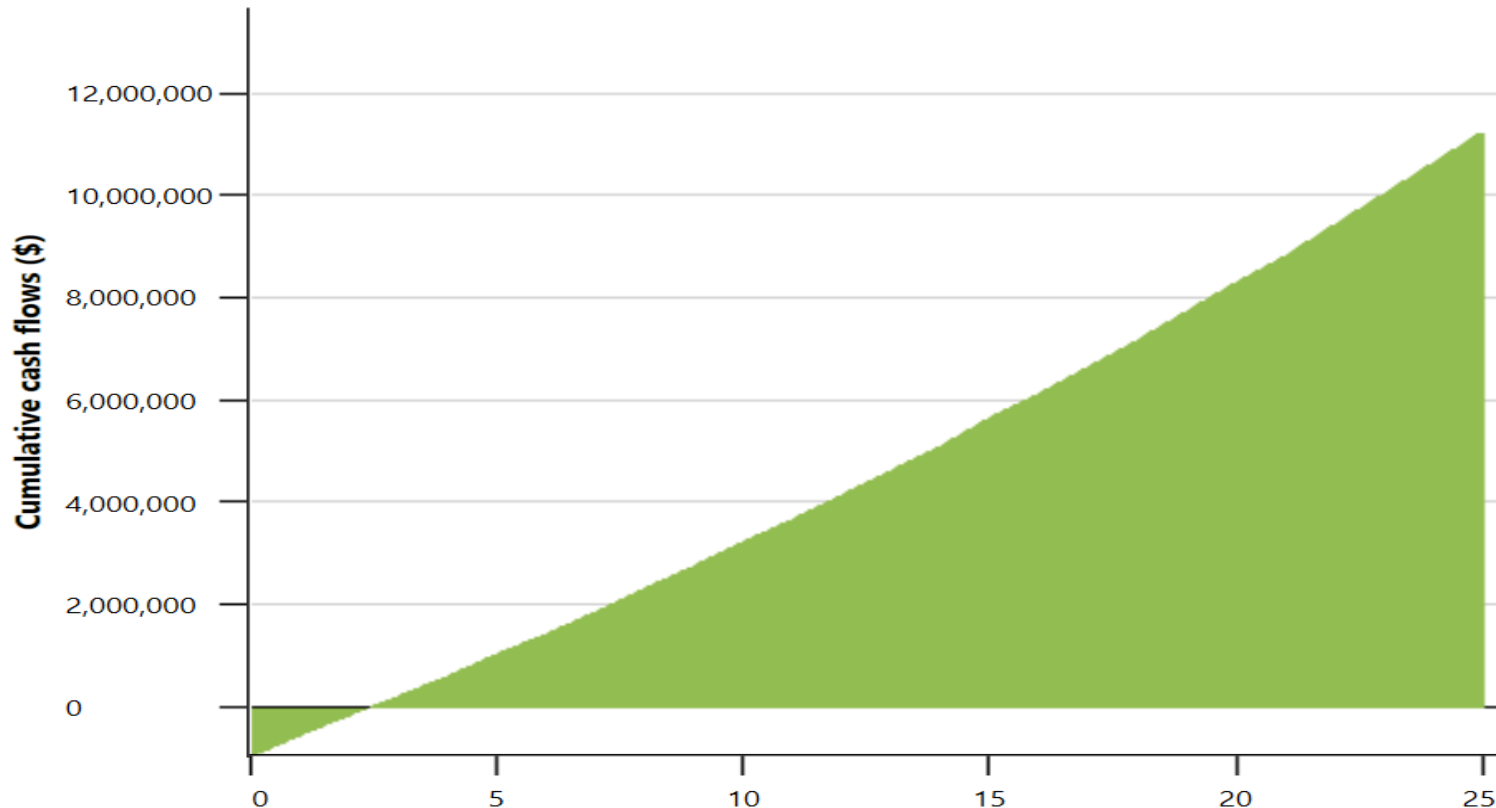

- Total Initial Cost = **\$960,000**
(Considering 1000 \$ /KWp - Ref: RETScreen)
- O&M Cost = **\$9,600/yr**
(Considering 10 \$ /KWp/yr - Ref: RETScreen)
- Savings = **\$373,200/yr**
(0.25\$/kWh in Syria, Reference: Assumption)
- NPV = **\$3,444,000**
- IRR = **41.7%**
- Simple payback = **2.6 yr**
- Benefit-Cost Ratio = **4.6**

Potential Jobs Created

Source: UNEP/ILO/IOE/ITUC, 2008.



7 - 11

Average employment (jobs per megawatt of solar photovoltaic system) over life of facility including manufacturing, construction, installation and operation & maintenance [ranges between 6.96 and 11.01 per MW](#)

Environmental Benefits

According to [RETScreen software](#), the GHG emission for 1 kWh is **0.707** kgCO₂/kWh. Referring to the energy produced by PV system which is around **1.532** GWh, the gross annual GHG emission reduction CO₂ is **1008** tCO₂/yr which would be equivalent to:



=



=



=



=



185 and light trucks not used per year

432,935 Liters of gasoline not consumed

310 Households reducing energy by 100%

347 Tonnes of waste recycled

93 Hectares of forest absorbing carbon

Additional Benefits

Source: RETScreen

Coverage of Energy Demand

100%
+
694 Citizen

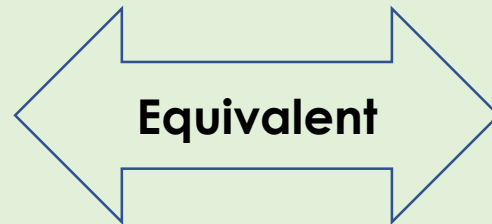

2226 Citizens

=

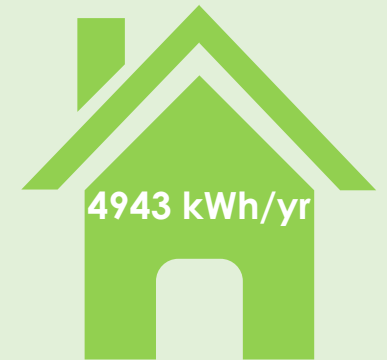

310 Households

The yearly average consumption of religious building is **120 kWh/m²**

10- Hassan II Mosque

Preliminary Solar Energy Assessment

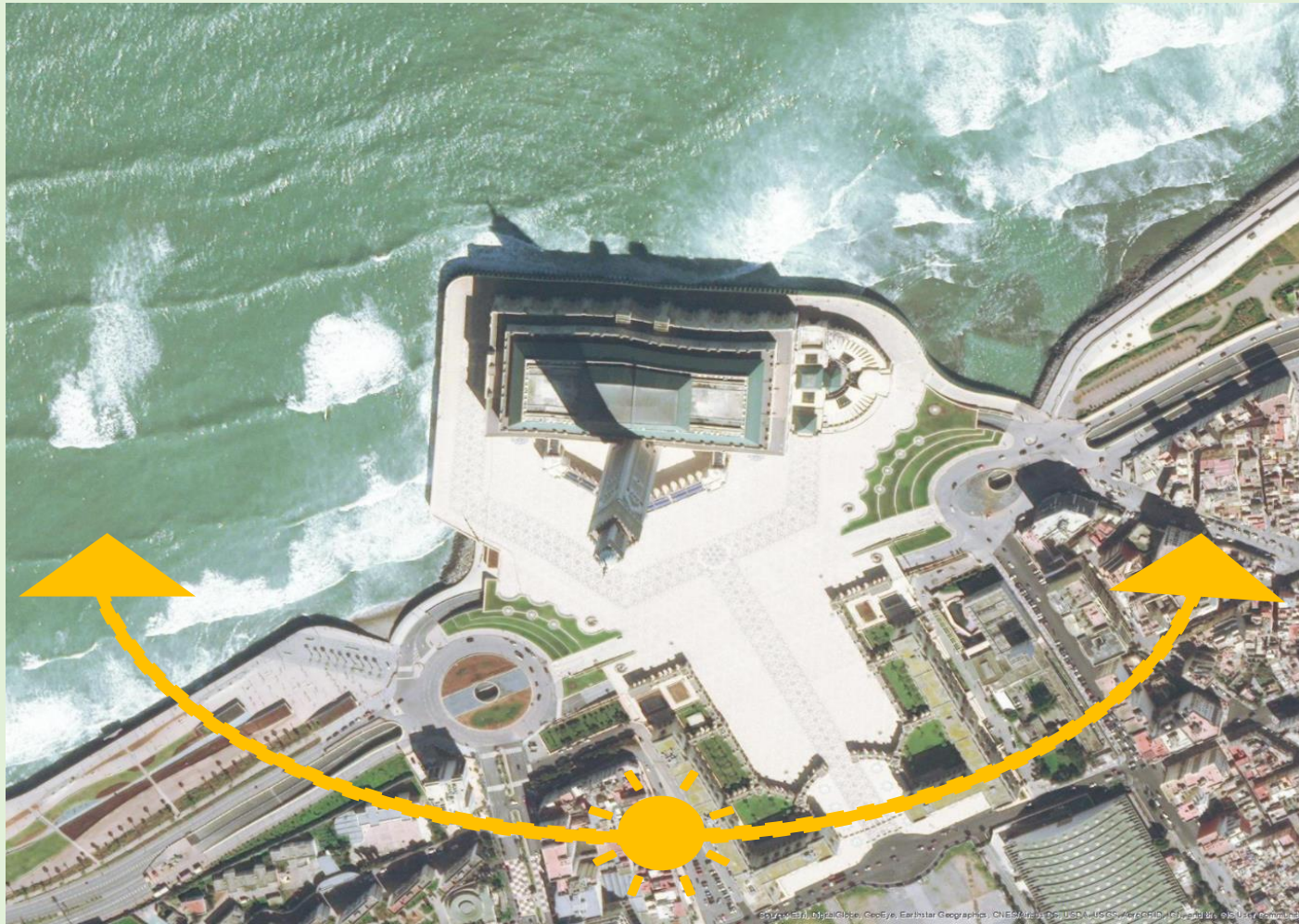

This mosque is located in Casablanca, Morocco. (33°36'27.9"N 7°38'01.3"W)

The optimal tilt angle of PV module is 29° and azimuth is south facing.

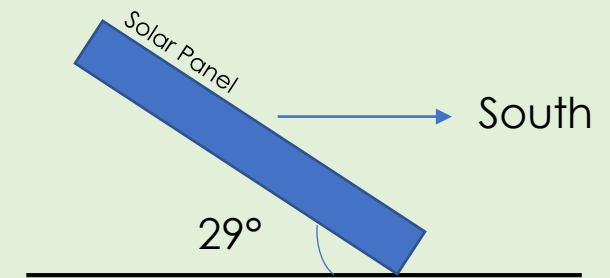

Source: Global Solar Atlas

Preliminary Solar Energy Assessment

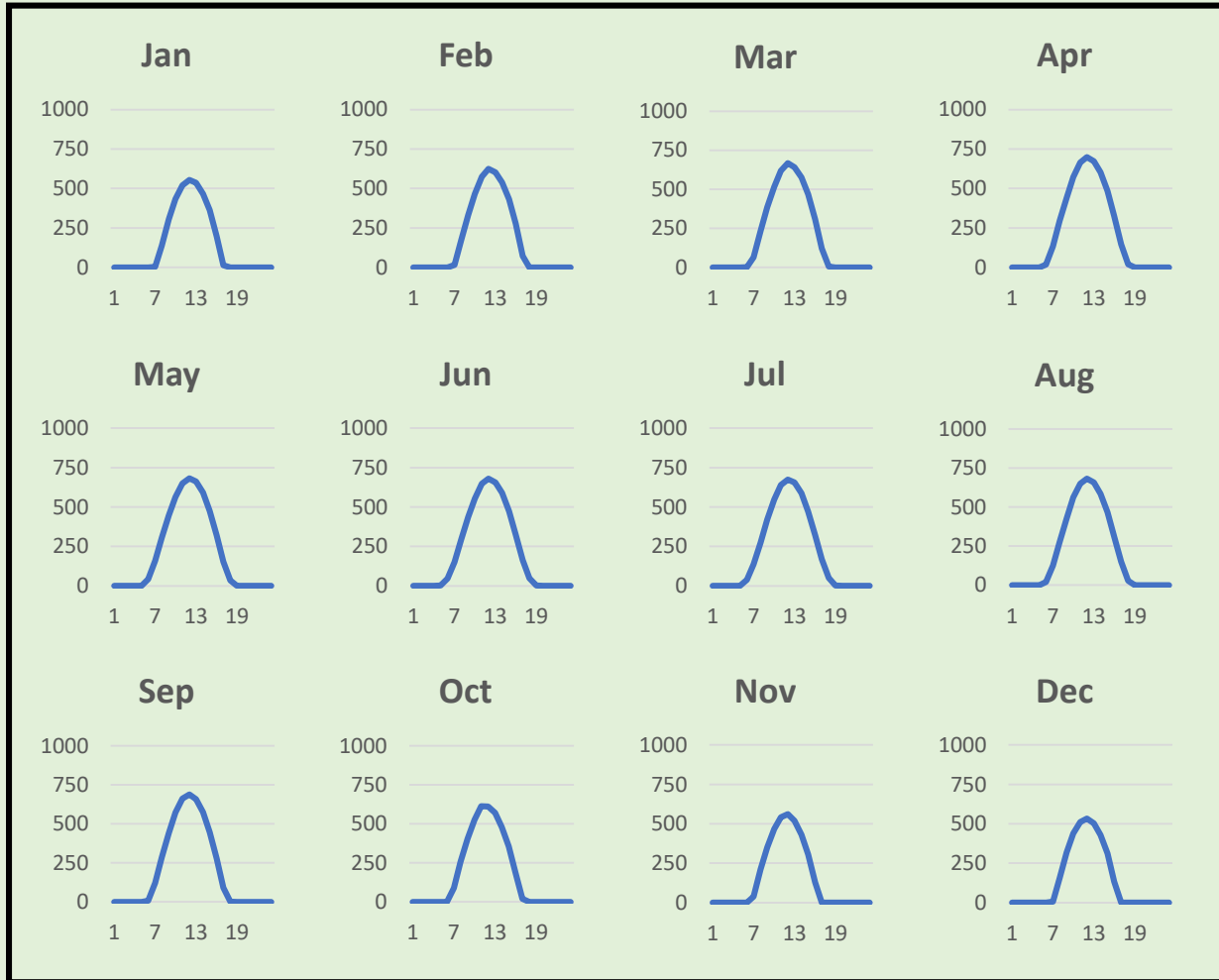

Average hourly profiles for each month
Total photovoltaic power output [Wh]

Total Photovoltaic Power Output per year
= 1620 kWh/kWp

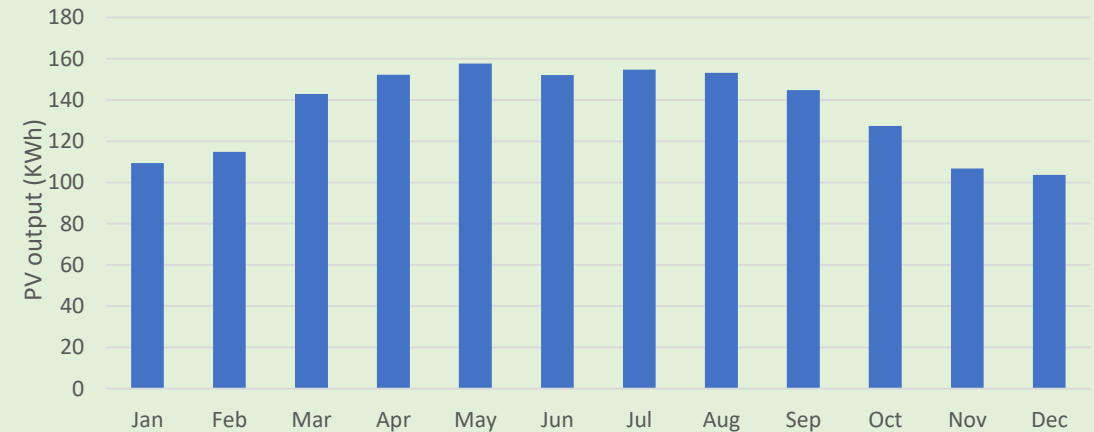

Monthly Averages

Total photovoltaic power output [kWh]

The figures show the hourly and monthly operation of 1 kWp PV system installed in the city of Casablanca. We can conclude that the energy production ranges between 103 kWh/yr and 157 kWh/yr, with high potential of solar energy. Data source : Global Solar Atlas

Preliminary Solar Site Assessment



Land Use Type

- Roads
-  Hassan II Mosque
-  Green Area
-  Urban Area
-  North Atlantic Ocean

The adjacent map shows the land use type at radius 2 km from the mosque. Hassan II mosque is located in a coastal high density urban area with a few green areas.

Preliminary Solar Site Assessment

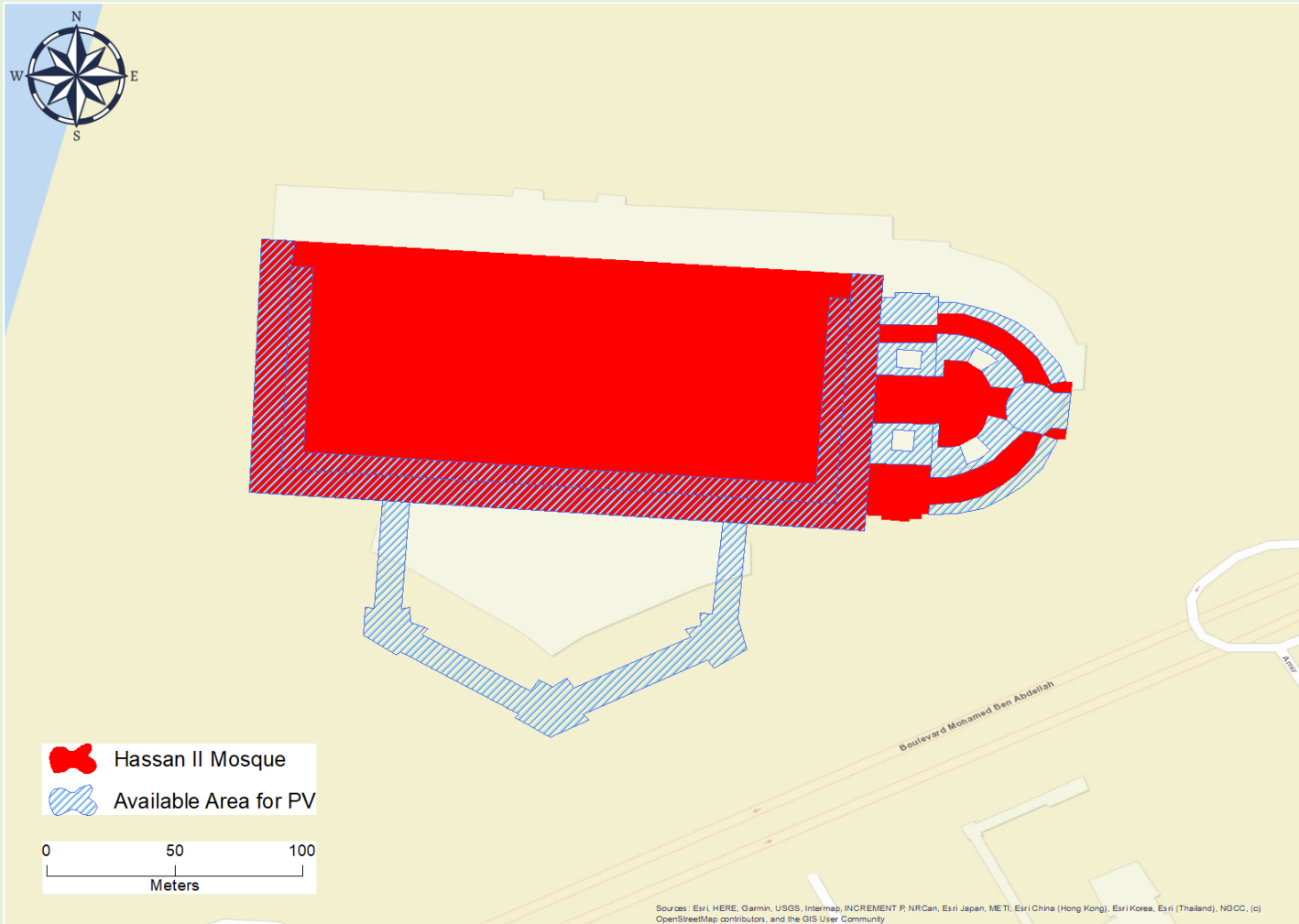

- The rooftop area of the mosque is: **27,800** m²
- Total area available for installing PV system is : **10,560** m²

PV Design of Mosque's Rooftop

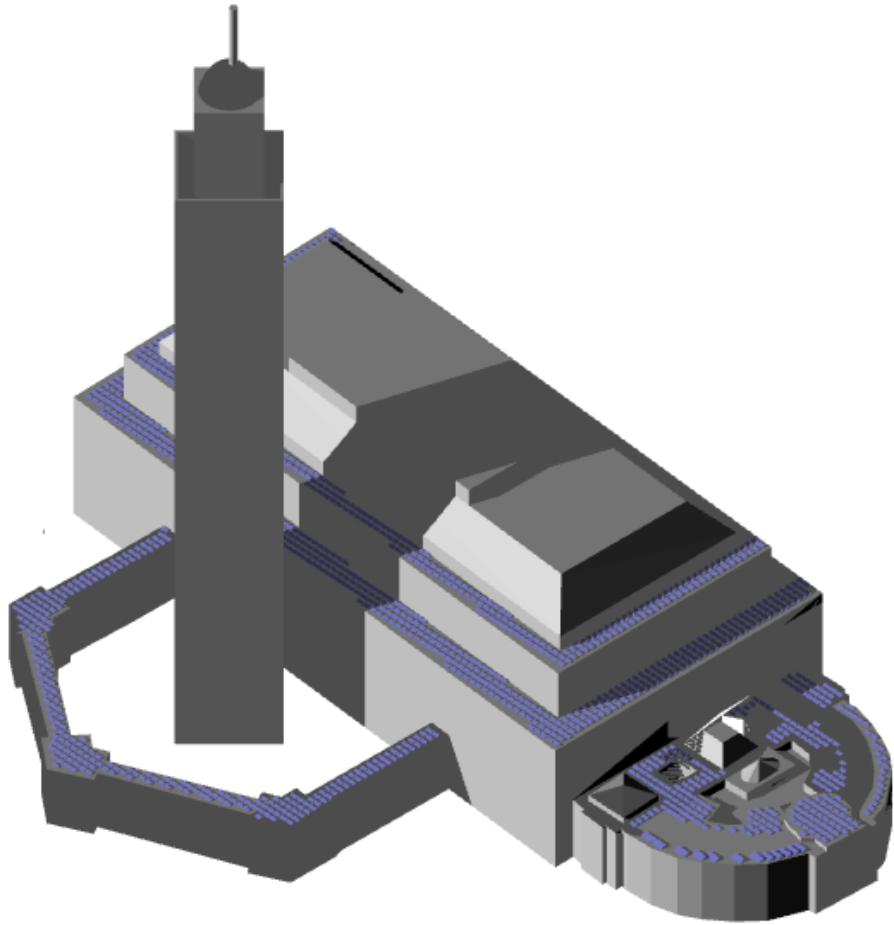

	Solar System Parameters
PV Module	Model: LR5-72 HPH 540 M
Manufacturer	Longi Solar
Nominal PV Power (kWp)	729
Total Number of modules	1350 (18 in series , 75 in Parallel)
Total Area of Modules (m ²)	3451
Total Number of Sheds	1350
Inverter	Model: SUNWAY TG750 1000V TE - 320 OD
Manufacturer	Santerno
Nominal Inverter Power (kWac)	665
System Production	
Total Produced Energy (MWh/year)	1057
System Performance Ratio (%)	70
System Cost	\$729,000

Economic Benefits

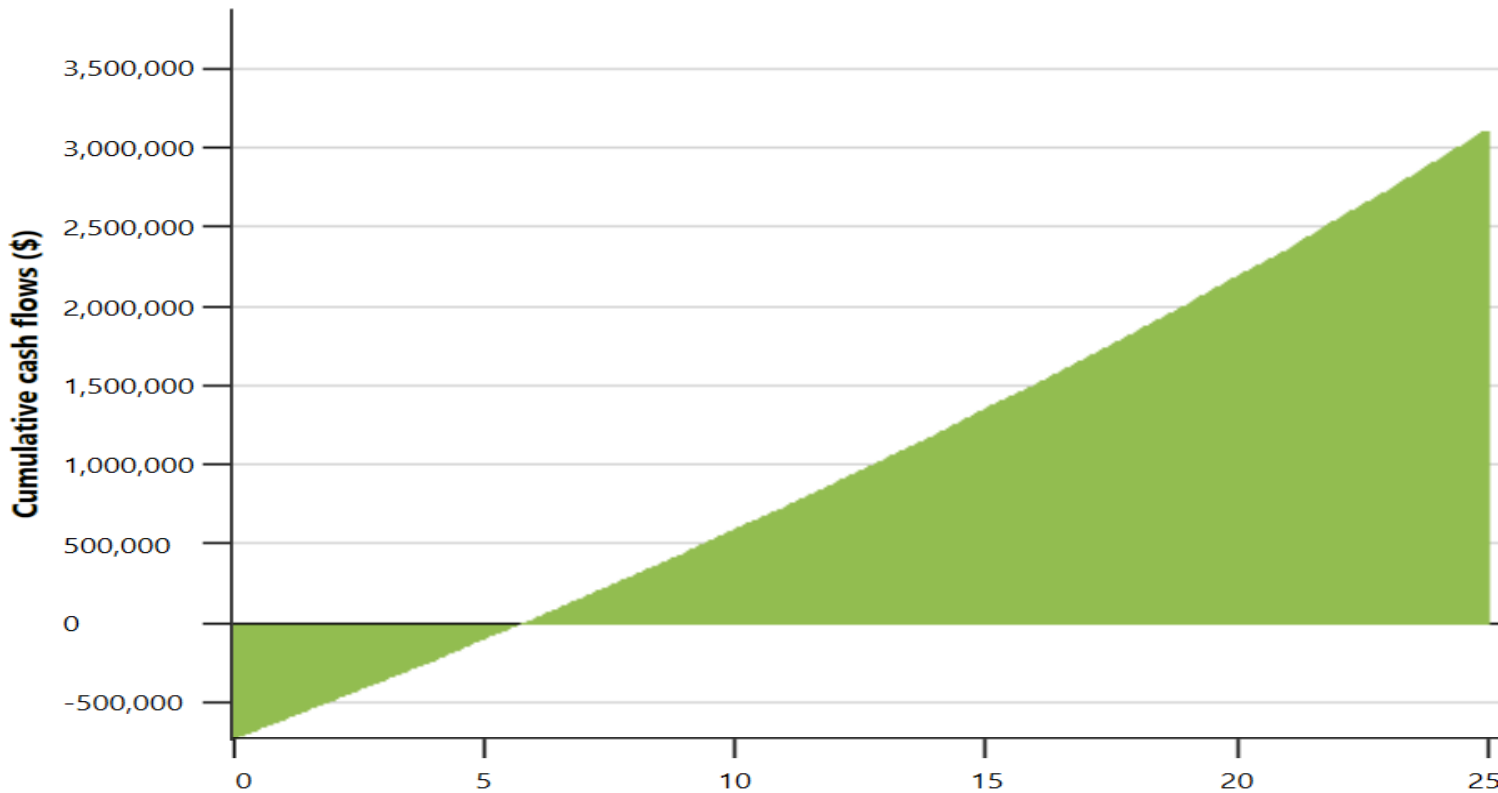

- Total Initial Cost = **\$729,000**
(Considering 1000 \$ /KWp - Ref: RETScreen)
- O&M Cost = **\$7,290/yr**
(Considering 10 \$ /KWp/yr - Ref: RETScreen)
- Savings = **\$117,410/yr**
(0.118\$/kWh in Morocco- Ref: Global Petrol Prices)
- NPV = **\$656,500**
- IRR = **18%**
- Simple payback = **6.2 yr**
- Benefit-Cost Ratio = **1.9**

Potential Jobs Created

Source: UNEP/ILO/IOE/ITUC, 2008.



5 - 8

Average employment (jobs per megawatt of solar photovoltaic system) over life of facility including manufacturing, construction, installation and operation & maintenance [ranges between 6.96 and 11.01 per MW](#)

Environmental Benefits

According to **RETScreen software**, the GHG emission for **1 kWh** is **0.680 kgCO₂/kWh**. Referring to the energy produced by PV system which is around **1.057 GWh**, the gross annual GHG emission reduction CO₂ is **668 tCO₂/yr** which would be equivalent to:



122 and light trucks not used per year

287,224 Liters of gasoline not consumed

810 Households reducing energy by 100%

231 Tonnes of waste recycled

62 Hectares of forest absorbing carbon

Additional Benefits

Source: RETScreen

Coverage of Energy Demand

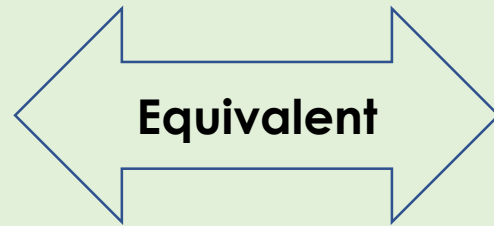
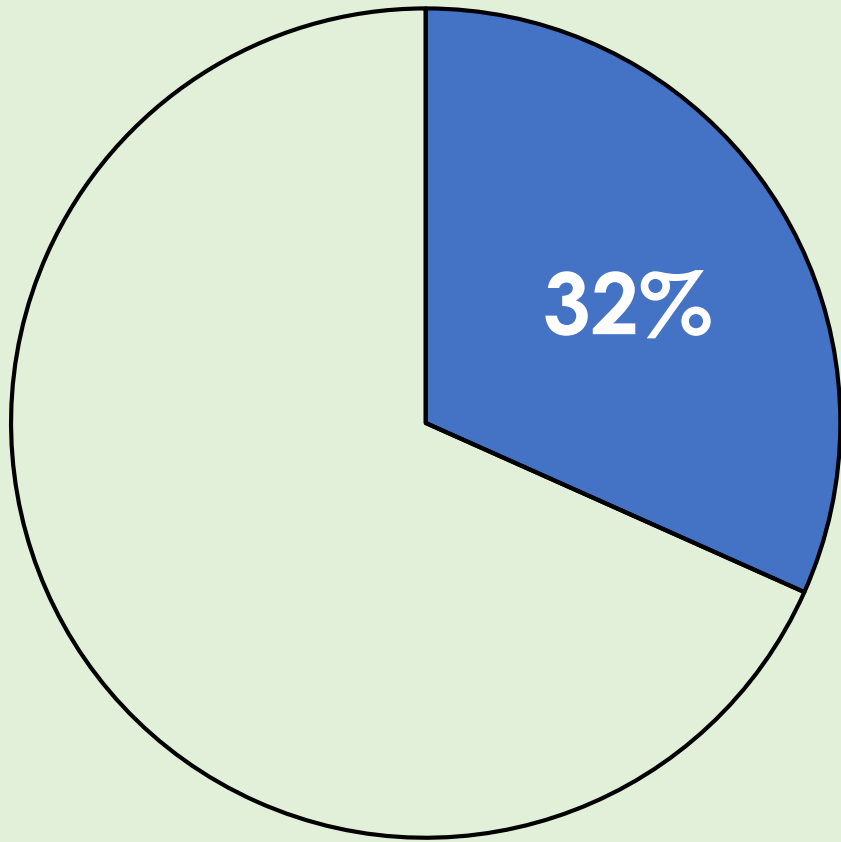

4314 Citizens

=

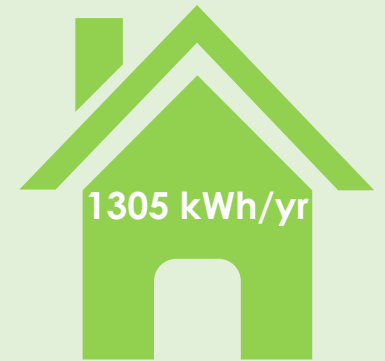

810 Households

The yearly average consumption of a religious building is **120** kWh/m²

Conclusion: The Result of 10 Mosques Going Solar

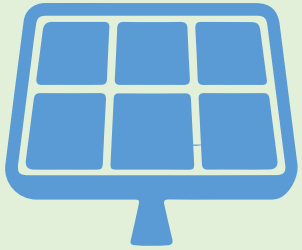

Reduces

22.3 GWh/yr
of annual energy
production

CO₂

12025 TCO₂/yr

Equivalent to:

New jobs
created



93 & 153

Saving
12025

TCO₂/yr

Is equivalent to:



5,166,844 Liters of
gasoline not
consumed

=



2203 cars and light
trucks not used
per year

=



Protection of
1107 hectares of
forest absorbing
carbon

=

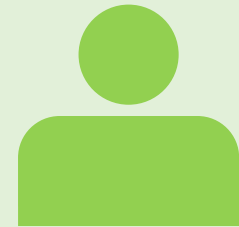

37980 persons
reducing energy
by 100%